

DATE: PROJECT: TYPE:

CATALOG NUMBER LOGIC:



**Designed for use with LED transformer*

***The 360SL cost is already included in the price of UPM, UPM dual, and Power Canopy.*

CATALOG NUMBER LOGIC

Example: B - MM - LED - e70 - SP - BLP - 12 - 11 - C - 360SL

MATERIAL

(Blank) - Aluminum B - Brass S - Stainless Steel

SERIES

MM - Mini-Micro

SOURCE

LED - with Non-Dimming Integral Driver*

LED TYPE

e70 - 3W LED/2700K e85 - 3W LED/2700K 90 CRI

e71 - 3W LED/3000K e86 - 3W LED/3000K 90 CRI

e72 - 3W LED/4000K e87 - 3W LED/3500K 80 CRI

e73 - 3W LED/Amber

OPTICS

NSP - Narrow Spot (17°) MFL - Medium Flood (28°)

SP - Spot (21°) ASY - Asymmetrical (17x31°)

FINISH (See page 2 for full-color swatches)

Standard Finishes (BZP, BZW, BLP, BLW, WHP, WHW, SAP, VER)

Premium Finish (ABP, AMG, AQW, BCM, BGE, BPP, CAP, CMG, CRM, HUG, NBP, OCP, RMG, SDS, SMG, TXF, WCP, WIR)

Also available in RAL Finishes

Brass Finishes (MAC, POL, MIT)

Stainless Steel Finishes (MAC, POL)

LENS TYPE

12 - Soft Focus 13 - Rectilinear

SHIELDING

11 - Honeycomb Baffle

CAP STYLE

A - 45°

B - 90°

C - Flush

D - 45° Less Weephole (Interior use only)

E - 90° Less Weephole (Interior use only)

OPTIONS

360SL - Rotational Knuckle Mounting System**

MOD OPTIONS

5 - 5 Ft Leads

25 - 25 Ft Leads

DATE: _____ PROJECT: _____ TYPE: _____

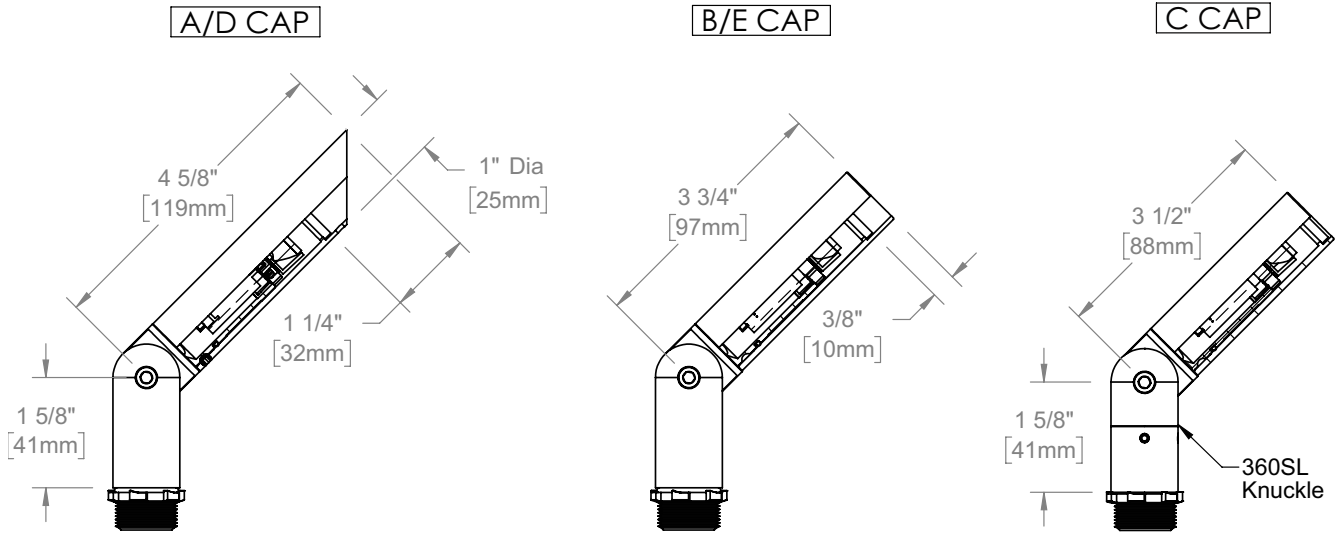

APPROXIMATE EPAs		
A/D CAP	B/E CAP	C CAP
0.05ft ²	0.04ft ²	0.04ft ²

APPROXIMATE FIXTURE WEIGHT		
ALUMINUM	BRASS	SSTL
0.96lbs	1.23lbs	1.20lbs

STANDARD FINISHES



PREMIUM FINISHES

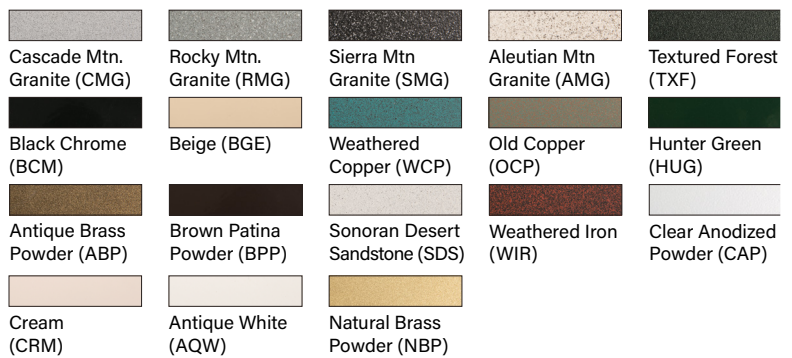

[Click Here](#) to view larger, full-color swatches of all available finishes on our website.

DATE: _____ PROJECT: _____ TYPE: _____

ACCESSORIES (Configure separately)

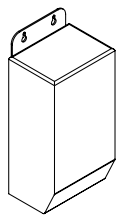

TR Series

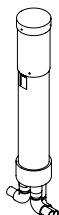

Power Pipe

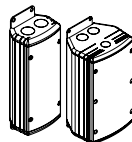

UPMRM

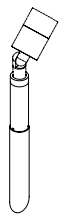

Power Pipe

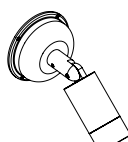

Power Canopy

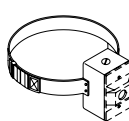

Tree Strap



Stems

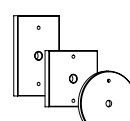

Canopies

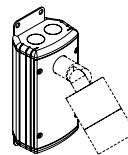

UPM

SPECIFICATIONS

<p>ELECTRICAL</p>	<p>WATTAGE WIRING REMOTE TRANSFORMER</p>	<p>3W LED XLPE, 18GA, 150C, 600V, rated and certified to UL3321. For use with 12VAC remote transformer or magnetic transformers only. B-K Lighting cannot guarantee performance with third party manufacturers' transformers.</p>
<p>PHYSICAL</p>	<p>MATERIALS BODY KNUCKLE CAP LENS LED OPTICS HARDWARE FINISH WARRANTY CERTIFICATION & LISTING</p>	<p>Furnished in copper-free aluminum (6061-T6), brass (360) or stainless steel (304). Unibody design with enclosed, water-proof wireway and integral heat sink is fully machined from solid billet. LOCK Knuckle is integral to the body and features an interior taper machined from solid billet and a second, reverse angle taper allowing full 180° vertical adjustment without the use of aim-limiting serrated teeth. High temperature, silicone 'O' Ring provides water-tight seal and compressive resistance to maintain fixture position. Design withstands 73 lbs. static load prior to movement for optical alignment with a 1/2" pipe thread for mounting. Optional 360SL provides biaxial source control with 360° horizontal rotation in addition to vertical adjustment. Fully machined and accommodates one (1) lens or louver media. Shock-resistant, tempered glass lens is factory adhered to fixture cap and provides hermetically sealed optical compartment. Integrated solid state system and modular design with electrical disconnects allow for easy field upgrade and maintenance. High power, forward throw source complies with ANSI C78.377 binning requirements and exceeds ENERGY STAR® lumen maintenance requirements. LM-80 certified components. Integral, constant current driver. 12VAC/VDC input. 50/60Hz. Proprietary input control scheme achieves power factor correction and eliminates inrush current (limited to <250mA non-dimming). Output, overvoltage, open-circuit, and short circuit protected. Conforms to Safety Std. C22.2 No. 250.13-12. Interchangeable OPTIKIT modules permit optical field changes. Color-code: Narrow Spot (NSP) = red; Spot (SP) = green; Medium Flood (MFL) = yellow; Wide Flood (WFL) = blue. Tamper-resistant, stainless steel hardware. LOCK aiming screw is black oxide treated for additional corrosion resistance. StarGuard, our 15-stage chromate-free process cleans and conversion coats aluminum components prior to application of Class 'A' TGIC polyester powder coating and is RoHS compliant. Powder coat or metal finish options available for brass material and metal finish option only for stainless steel material. 5-year limited warranty. ITL tested to IESNA LM-79. UL Listed. Certified to CAN/CSA/ANSI Standards. RoHS compliant. Suitable for indoor or outdoor use, in wet locations, and for installation within 4' of the ground. IP66 Rated. Made in the USA with sustainable processes.</p>



LAMP & DRIVER DATA (e70, e71, e72, e73)

DATE: _____ PROJECT: _____ TYPE: _____

DRIVER DATA	Input Volts	InRush Current	Operating Current	Operation Ambient Temperature
	12VAC/DC 50/60Hz	<250mA (non-dimmed)	700mA	-22°F-194°F (-30°C - 90°C)

LM79 DATA				L70 DATA		OPTICAL DATA		
BK No.	CCT (Typ.)	CRI (Typ.)	Input Watts (Typ.)	Minimum Rated Life (hrs.) 70% of initial lumens (L ₇₀)		Angle	CBCP	Delivered Lumens
e70	2700K	80	3	50,000		17°	1347	167
	2700K	80	3	50,000		21°	664	139
	2700K	80	3	50,000		28°	524	149
	2700K	~	3	50,000		17°x31°	613	151
e71	3000K	80	3	50,000		17°	1411	175
	3000K	80	3	50,000		21°	695	146
	3000K	80	3	50,000		28°	548	156
	3000K	~	3	50,000		17°x31°	642	158
e72	4000K	80	3	50,000		17°	1585	197
	4000K	80	3	50,000		21°	781	164
	4000K	80	3	50,000		28°	616	175
	4000K	~	3	50,000		17°x31°	721	178
e73	Amber (590nm)	~	3	50,000		~	~	~

OPTICS

Optic	Angle
NSP - Narrow Spot	17°
SP - Spot	21°
MFL - Medium Flood	28°
ASY - Asymmetrical	17°x31°

B-K LIGHTING

MADE IN THE USA

559.438.5800 | INFO@BKLIGHTING.COM | BKLIGHTING.COM

THIS DOCUMENT CONTAINS PROPRIETARY INFORMATION OF B-K LIGHTING, INC. AND ITS RECEIPT OR POSSESSION DOES NOT CONVEY ANY RIGHTS TO REPRODUCE, DISCLOSE ITS CONTENTS, OR TO MANUFACTURE, USE OR SELL ANYTHING IT MAY DESCRIBE. REPRODUCTION, DISCLOSURE OR USE WITHOUT SPECIFIC WRITTEN AUTHORIZATION OF B-K LIGHTING, INC. IS STRICTLY FORBIDDEN.