

DENALI - POWER PIPE II INTEGRAL DRIVER HOUSING (BLUETOOTH) ORDER FIXTURE SEPARATELY.

DATE:	PROJECT:	TYPE:
-------	----------	-------

CATALOG NUMBER LOGIC:



CATALOG NUMBER LOGIC

Example: PPII - S12 - BT - BZW - B - MT -SF

MATERIAL

Aluminum

SERIES

PPII - Power Pipe II System

TYPE*

S12 - 12" Stake

S18 - 18" Stake

J12 - 12" Junction Box

J18 - 18" Junction Box

CONTROL TYPE

010 - 0-10V Wired Installation (Requires 2 sets of 0-10V controls, sold separately)

BT - Bluetooth (For use with 20W LED color tuning fixtures. See requirements below.)**

FINISH

Standard Finishes (BZP, BZW, BLP, BLW, WHP, WHW, SAP, VER)

Premium Finish (ABP, AMG, AQW, BCM, BGE, BPP, CAP, CMG, CRM, HUG, NBP, OCP, RMG, SDS, SMG, TXF, WCP, WIR)

(Also available in RAL Finishes. See submittal SUB-1439-00)

CAP STYLE

B - Single Hole Cap

INPUT VOLTAGE

MT - 120-277 VAC (For use with 20W LED color tuning fixtures)

OPTIONS

SF - Stability Flange

**Includes 12" or 18" Power Pipe with Driver Housing*

***Bluetooth control system for use with iPad Touch 5 or later, iPad Mini, iPad3 (2012) or later or iPhone 4S or later. 20W fixture compatible only.*

B-K LIGHTING

MADE IN THE USA

559.438.5800 | INFO@BKLIGHTING.COM | BKLIGHTING.COM

THIS DOCUMENT CONTAINS PROPRIETARY INFORMATION OF B-K LIGHTING, INC. AND ITS RECEIPT OR POSSESSION DOES NOT CONVEY ANY RIGHTS TO REPRODUCE, DISCLOSE ITS CONTENTS, OR TO MANUFACTURE, USE OR SELL ANYTHING IT MAY DESCRIBE. REPRODUCTION, DISCLOSURE OR USE WITHOUT SPECIFIC WRITTEN AUTHORIZATION OF B-K LIGHTING, INC. IS STRICTLY FORBIDDEN.

12/06/2022 SKU-1236

DENALI - POWER PIPE II INTEGRAL DRIVER HOUSING (BLUETOOTH) ORDER FIXTURE SEPARATELY.

DATE: _____ PROJECT: _____ TYPE: _____

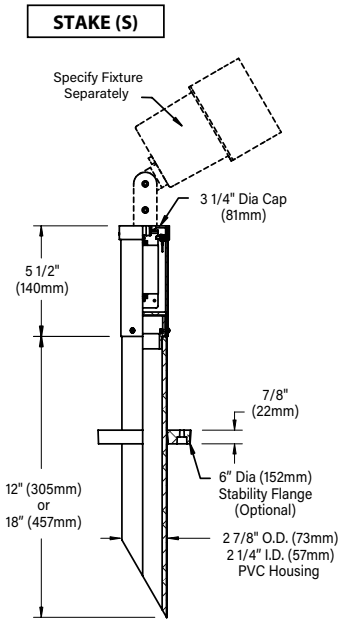

0-10V WIRED CONTROL

For use with: **C22 - 20WLED/1650-8000K + Dimming and CCT only**
(0-10V Wired Installation)

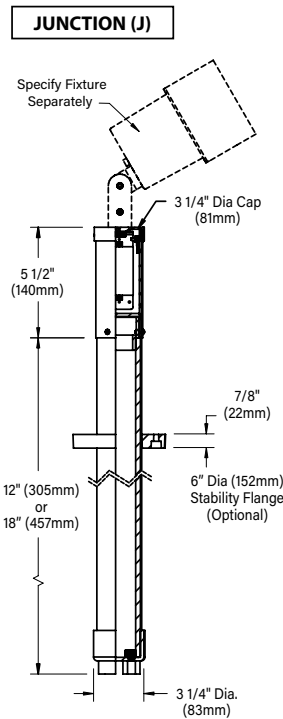
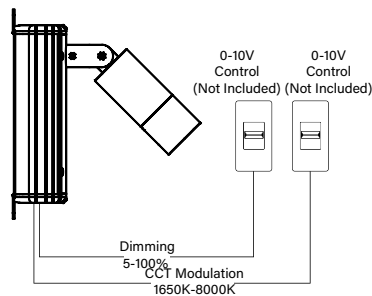

IOS DEVICE CONTROL

For use with: **C22 - 20WLED/1650-8000K + Saturation and Hue**
(Bluetooth Installation)

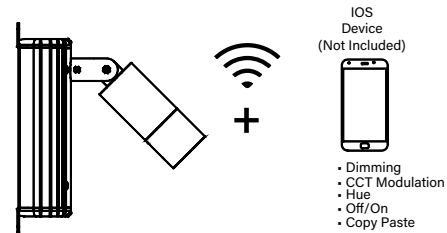

CAP STYLE

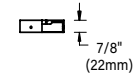
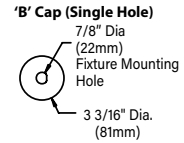

Bottom View of 'J'

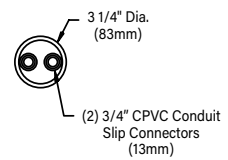

STANDARD FINISHES



PREMIUM FINISHES

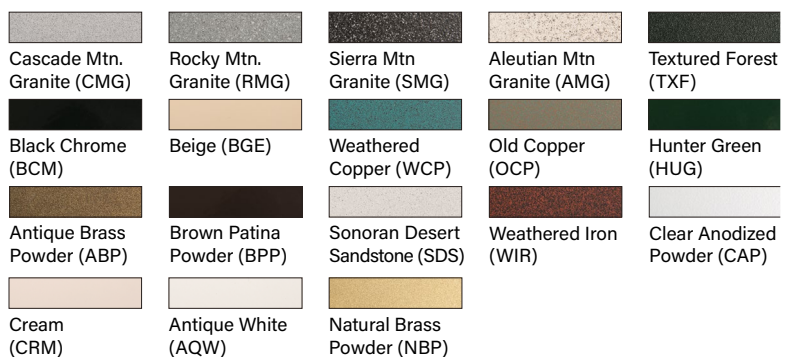

[Click Here](#) to view larger, full-color swatches of all available finishes on our website.

B-K LIGHTING

MADE IN THE USA

559.438.5800 | INFO@BKLIGHTING.COM | BKLIGHTING.COM

DENALI - POWER PIPE II INTEGRAL DRIVER HOUSING (BLUETOOTH) ORDER FIXTURE SEPARATELY.

DATE:	PROJECT:	TYPE:
-------	----------	-------

ACCESSORIES (Configure separately)

SPECIFICATIONS

Electrical	INSPIRATION (BLUETOOTH WIRELESS TECHNOLOGY)	Wireless communication system creates dynamic lumen response at the individual fixture. Indexed (100% to 5% nom.) lumen output. Maintains output at desired level or may be changed as conditions require via exclusive mobile application. App available at the Apple App® Store. CCT modulation between 1650K through 4000K. Full saturation and hue control enables selection of any single color point off the Planckian curve for dynamic full color output. A copy/paste function permits replication of the current selection to other modules within the wireless network. Wireless control up to 5 feet.
	BLUETOOTH CONNECTIVITY REQUIREMENTS	iOS device (by others) with Inspiration Control System app is required for wireless Bluetooth® control. Works with iPhone® (4S or newer); iPad® (3rd generation or newer); iPad mini®; iPad Air®; iPod® Touch (5th generation or newer).
	0-10V WIRED CONTROL	For 0-10V industry wired installations, iOS device may also be utilized to select a single color point off the Planckian curve for dynamic full color output with the remaining functions enabled by the 0-10V controls. Two (2) two sets of control wires wired direct to the fixture.
	WIRING DRIVER	18 AWG, 300V, 150°C rated and certified to UL 1659 standard. Requires two (2) sets of 0-10V industry wired controls wired direct to the fixture. One provides CCT modulation between 1650K through 8000K in 1% increments. The second enables 5-100% dimming in 1% increments. iOS device may also be utilized to select a single color point off the Planckian curve for dynamic full color output with the remaining functions enabled by the 0-10V controls.
PHYSICAL	INSTALLATION	Provides a clean, architectural transition from wiring system to fixture. 2" Schedule 80 PVC pipe. For direct burial in soil or concrete. Available in 12" and 18" lengths. Available in three installation types:
	STAKE (TYPE S)	60° angled bottom designed for use with conduit or direct burial low voltage cable.
	JUNCTION BOX (TYPE J)	Includes two (2) 3/4" PVC slip connectors for branch circuit wiring.
	STABILITY FLANGE	Optional 6" diameter, molded stability flange simplifies installation and projects into substrate to simplify installation and reinforce housing stability.
	CAP STYLE	Machined from copper-free aluminum.
	DRIVER HOUSING	Fully machined from copper-free aluminum. Stainless steel hardware. High temperature, silicone 'O' Ring provides watertight seal.
	HARDWARE	Tamper-resistant, stainless steel hardware.
	FINISH	StarGuard, our 15-stage, chromate-free process cleans and conversion coats aluminum components prior to application of Class 'A' TGIC polyester powder coating and is RoHS compliant.
	WARRANTY	5-year limited warranty.
	CERTIFICATION & LISTING	Certified to CAN/CSA/ANSI Standards. UL Listed. RoHS compliant. Made in USA with sustainable processes.



B-K LIGHTING	MADE IN THE USA	559.438.5800 INFO@BKLIGHTING.COM BKLIGHTING.COM
---------------------	------------------------	----------------------------------------------------------------------------------------------------------------------------------