

DATE: _____ PROJECT: _____ TYPE: _____

CATALOG NUMBER LOGIC:



*Lamp details available on the 3rd page.

**For use in Back Box installation only.

CATALOG NUMBER LOGIC

Example: B - VS - MR - 359 - BLW - 9 - 11 - TP

MATERIAL

(Blank) - Aluminum B - Brass S - Stainless Steel

INSTALLATION

(Blank) - Back Box

SERIES

VS - Versa Star

SOURCE

MR - MR16 Lamp

LAMP TYPE

0 - MR16 HALOGEN LAMP (Furnished by others)

MR16 LED (This choice requires lamp number selection)*

FINISH (See page 2 for full-color swatches)

Standard Finishes (BZP, BZW, BLP, BLW, WHP, WHW, SAP, VER)

Premium Finish (ABP, AMG, AQW, BCM, BGE, BPP, CAP, CMG, CRM, HUG, NBP, OCP, RMG, SDS, SMG, TXF, WCP, WIR)

Also available in RAL Finishes

Brass Finishes (MAC, POL, MIT)

Stainless Steel Finishes (MAC, POL)

LENS TYPE

9 - Clear (Standard)

10 - Spread 12 - Soft Focus 13 - Rectilinear

SHIELDING

11 - Honeycomb Baffle

OPTION

AJ - Adjustable Lamp Bracket**

TP - Thermal Protection (20W lamp max.)**

DATE: _____ PROJECT: _____ TYPE: _____

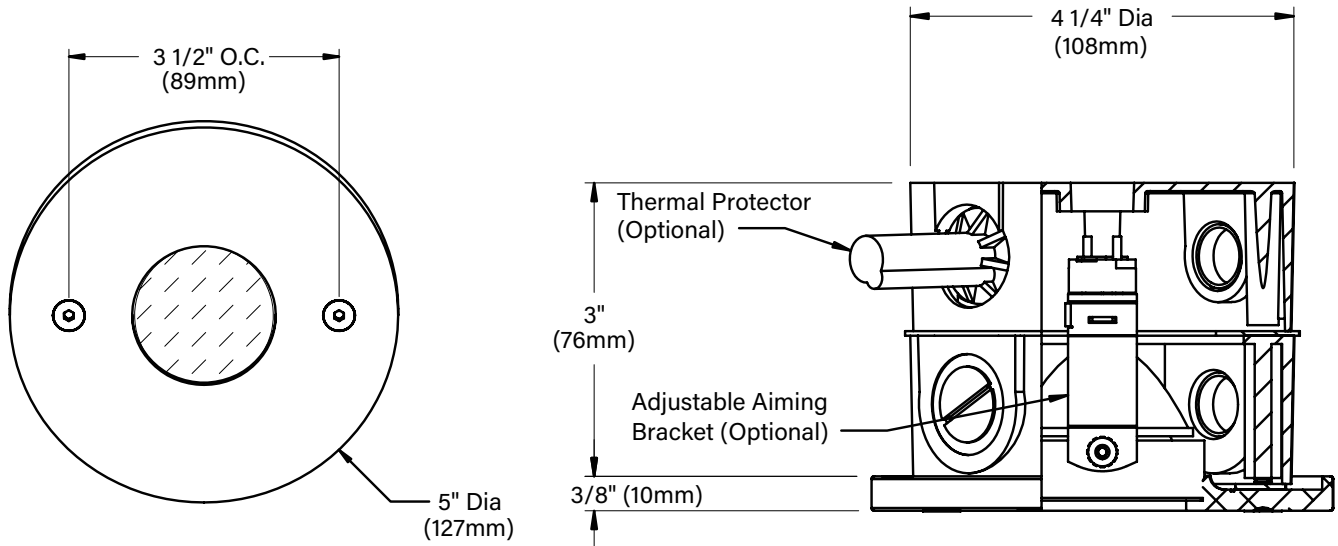

STANDARD FINISHES



PREMIUM FINISHES

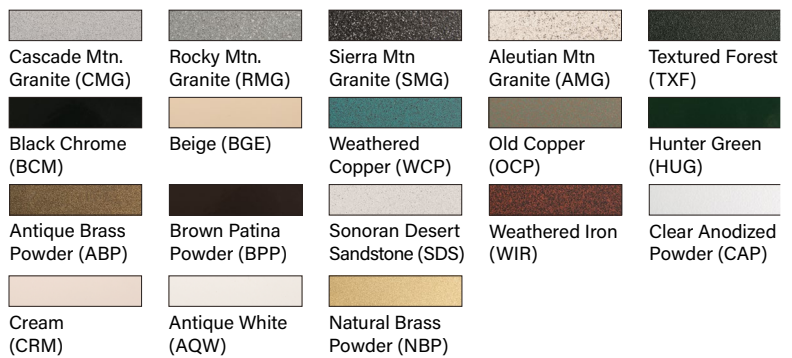





[Click Here](#) to view larger, full-color swatches of all available finishes on our website.

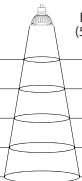

By SORAA™

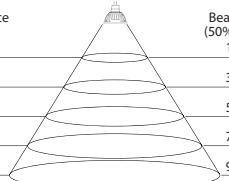
MR16 LED LAMP

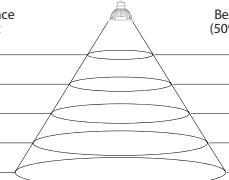
<p>B-K Lamp # 359 Base: GU5.3 Bi-Pin Input Voltage: 12V CCT: 2700K Beam: 10° Spot</p>	<p>Mfg. #: MR16- SM16-07-10D-827-H1 Wattage: 7.5W Lamp Efficacy: 77 (Lm/W) Rated Life: 35,000 hrs</p>	<p>CBCP (cd): 8000 CRI: >90 Power Factor: 0.92 Dimmable: Yes Lumens: 575</p>	 <table border="1"> <thead> <tr> <th>Distance feet</th> <th>Beam Dia. (50% CBCP)</th> <th>Footcandles</th> </tr> </thead> <tbody> <tr><td>3'</td><td>0.5'</td><td>634</td></tr> <tr><td>6'</td><td>1.0'</td><td>160</td></tr> <tr><td>9'</td><td>1.6'</td><td>69</td></tr> <tr><td>12'</td><td>2.1'</td><td>40</td></tr> <tr><td>15'</td><td>2.6'</td><td>23</td></tr> </tbody> </table>	Distance feet	Beam Dia. (50% CBCP)	Footcandles	3'	0.5'	634	6'	1.0'	160	9'	1.6'	69	12'	2.1'	40	15'	2.6'	23
Distance feet	Beam Dia. (50% CBCP)	Footcandles																			
3'	0.5'	634																			
6'	1.0'	160																			
9'	1.6'	69																			
12'	2.1'	40																			
15'	2.6'	23																			
<p>B-K Lamp # 361 Base: GU5.3 Bi-Pin Input Voltage: 12V CCT: 2700K Beam: 25° Narrow Flood</p>	<p>Mfg. #: MR16- SM16-07-25D-827-H1 Wattage: 7.5W Lamp Efficacy: 80 (Lm/W) Rated Life: 35,000 hrs</p>	<p>CBCP (cd): 3170 CRI: >90 Power Factor: 0.92 Dimmable: Yes Lumens: 600</p>	 <table border="1"> <thead> <tr> <th>Distance feet</th> <th>Beam Dia. (50% CBCP)</th> <th>Footcandles</th> </tr> </thead> <tbody> <tr><td>3'</td><td>1.3'</td><td>251</td></tr> <tr><td>6'</td><td>2.7'</td><td>63</td></tr> <tr><td>9'</td><td>4.0'</td><td>27</td></tr> <tr><td>12'</td><td>5.3'</td><td>16</td></tr> <tr><td>15'</td><td>6.7'</td><td>9</td></tr> </tbody> </table>	Distance feet	Beam Dia. (50% CBCP)	Footcandles	3'	1.3'	251	6'	2.7'	63	9'	4.0'	27	12'	5.3'	16	15'	6.7'	9
Distance feet	Beam Dia. (50% CBCP)	Footcandles																			
3'	1.3'	251																			
6'	2.7'	63																			
9'	4.0'	27																			
12'	5.3'	16																			
15'	6.7'	9																			
<p>B-K Lamp # 362 Base: GU5.3 Bi-Pin Input Voltage: 12V CCT: 2700K Beam: 36° Flood</p>	<p>Mfg. #: MR16- SM16-07-36D-827-H1 Wattage: 7.5W Lamp Efficacy: 80 (Lm/W) Rated Life: 35,000 hrs</p>	<p>CBCP (cd): 1550 CRI: >90 Power Factor: 0.92 Dimmable: Yes Lumens: 600</p>	 <table border="1"> <thead> <tr> <th>Distance feet</th> <th>Beam Dia. (50% CBCP)</th> <th>Footcandles</th> </tr> </thead> <tbody> <tr><td>3'</td><td>1.9'</td><td>119</td></tr> <tr><td>6'</td><td>3.9'</td><td>30</td></tr> <tr><td>9'</td><td>5.8'</td><td>13</td></tr> <tr><td>12'</td><td>7.8'</td><td>7</td></tr> <tr><td>15'</td><td>9.7'</td><td>4</td></tr> </tbody> </table>	Distance feet	Beam Dia. (50% CBCP)	Footcandles	3'	1.9'	119	6'	3.9'	30	9'	5.8'	13	12'	7.8'	7	15'	9.7'	4
Distance feet	Beam Dia. (50% CBCP)	Footcandles																			
3'	1.9'	119																			
6'	3.9'	30																			
9'	5.8'	13																			
12'	7.8'	7																			
15'	9.7'	4																			
<p>B-K Lamp # 363 Base: GU5.3 Bi-Pin Input Voltage: 12V CCT: 3000K Beam: 10° Spot</p>	<p>Mfg. #: MR16- SM16-07-10D-830-H1 Wattage: 7.5W Lamp Efficacy: 80 (Lm/W) Rated Life: 35,000 hrs</p>	<p>CBCP (cd): 8400 CRI: >90 Power Factor: 0.92 Dimmable: Yes Lumens: 600</p>	 <table border="1"> <thead> <tr> <th>Distance feet</th> <th>Beam Dia. (50% CBCP)</th> <th>Footcandles</th> </tr> </thead> <tbody> <tr><td>3'</td><td>0.5'</td><td>666</td></tr> <tr><td>6'</td><td>1.0'</td><td>168</td></tr> <tr><td>9'</td><td>1.6'</td><td>72</td></tr> <tr><td>12'</td><td>2.1'</td><td>42</td></tr> <tr><td>15'</td><td>2.6'</td><td>24</td></tr> </tbody> </table>	Distance feet	Beam Dia. (50% CBCP)	Footcandles	3'	0.5'	666	6'	1.0'	168	9'	1.6'	72	12'	2.1'	42	15'	2.6'	24
Distance feet	Beam Dia. (50% CBCP)	Footcandles																			
3'	0.5'	666																			
6'	1.0'	168																			
9'	1.6'	72																			
12'	2.1'	42																			
15'	2.6'	24																			
<p>B-K Lamp # 365 Base: GU5.3 Bi-Pin Input Voltage: 12V CCT: 3000K Beam: 25° Narrow Flood</p>	<p>Mfg. #: MR16- SM16-07-25D-830-H1 Wattage: 7.5W Lamp Efficacy: 84 (Lm/W) Rated Life: 35,000 hrs</p>	<p>CBCP (cd): 3300 CRI: >90 Power Factor: 0.92 Dimmable: Yes Lumens: 630</p>	 <table border="1"> <thead> <tr> <th>Distance feet</th> <th>Beam Dia. (50% CBCP)</th> <th>Footcandles</th> </tr> </thead> <tbody> <tr><td>3'</td><td>1.3'</td><td>266</td></tr> <tr><td>6'</td><td>2.7'</td><td>67</td></tr> <tr><td>9'</td><td>4.0'</td><td>29</td></tr> <tr><td>12'</td><td>5.3'</td><td>17</td></tr> <tr><td>15'</td><td>6.7'</td><td>10</td></tr> </tbody> </table>	Distance feet	Beam Dia. (50% CBCP)	Footcandles	3'	1.3'	266	6'	2.7'	67	9'	4.0'	29	12'	5.3'	17	15'	6.7'	10
Distance feet	Beam Dia. (50% CBCP)	Footcandles																			
3'	1.3'	266																			
6'	2.7'	67																			
9'	4.0'	29																			
12'	5.3'	17																			
15'	6.7'	10																			
<p>B-K Lamp # 366 Base: GU5.3 Bi-Pin Input Voltage: 12V CCT: 3000K Beam: 36° Flood</p>	<p>Mfg. #: MR16- SM16-07-36D-830-H1 Wattage: 7.5W Lamp Efficacy: 84 (Lm/W) Rated Life: 35,000 hrs</p>	<p>CBCP (cd): 1650 CRI: >90 Power Factor: 0.92 Dimmable: Yes Lumens: 630</p>	 <table border="1"> <thead> <tr> <th>Distance feet</th> <th>Beam Dia. (50% CBCP)</th> <th>Footcandles</th> </tr> </thead> <tbody> <tr><td>3'</td><td>1.9'</td><td>125</td></tr> <tr><td>6'</td><td>3.9'</td><td>32</td></tr> <tr><td>9'</td><td>5.8'</td><td>14</td></tr> <tr><td>12'</td><td>7.8'</td><td>8</td></tr> <tr><td>15'</td><td>9.7'</td><td>5</td></tr> </tbody> </table>	Distance feet	Beam Dia. (50% CBCP)	Footcandles	3'	1.9'	125	6'	3.9'	32	9'	5.8'	14	12'	7.8'	8	15'	9.7'	5
Distance feet	Beam Dia. (50% CBCP)	Footcandles																			
3'	1.9'	125																			
6'	3.9'	32																			
9'	5.8'	14																			
12'	7.8'	8																			
15'	9.7'	5																			

B-K LIGHTING

MADE IN THE USA

559.438.5800 | INFO@BKLIGHTING.COM | BKLIGHTING.COM

THIS DOCUMENT CONTAINS PROPRIETARY INFORMATION OF B-K LIGHTING, INC. AND ITS RECEIPT OR POSSESSION DOES NOT CONVEY ANY RIGHTS TO REPRODUCE, DISCLOSE ITS CONTENTS, OR TO MANUFACTURE, USE OR SELL ANYTHING IT MAY DESCRIBE. REPRODUCTION, DISCLOSURE OR USE WITHOUT SPECIFIC WRITTEN AUTHORIZATION OF B-K LIGHTING, INC. IS STRICTLY FORBIDDEN.

DATE: _____ PROJECT: _____ TYPE: _____

ACCESSORIES (Configure separately)

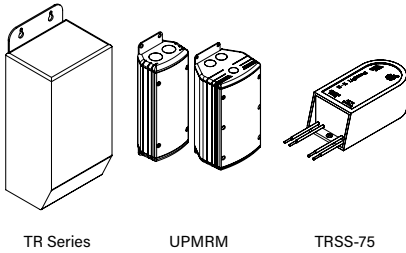

TR Series

UPMRM

TRSS-75

SPECIFICATIONS

ELECTRICAL	WATTAGE	7.5W
	SOCKET	Specification grade, ceramic body, miniature bi-pin quartz lamp holder. GU5.3 base. Nickel alloy contacts and heat resistant, spring loaded, stainless steel lamp retaining clips.
	WIRING	Teflon* coated wire, 18AWG, 600V, 250° C rated and certified to UL 1659 standard.
	TRANSFORMER	For use with 12VAC remote transformer.
PHYSICAL	MATERIALS	Furnished in copper-free aluminum (6061-T6), brass (360) or stainless steel (304).
	BACKBOX	Round, 4-1/4' x 3-1/8' deep, cast aluminum construction with two (2) mounting tabs. Front access for wire connection and inspection. Provided with five (5) 1/2' NPS tapped holes and four (4) plugs. Suitable for concrete pour.
	FACEPLATE	Machined from solid, copper-free aluminum. Also available in solid, machined brass and solid, machined stainless steel. Countersunk holes provide for flush hardware mounting with two (2) tamper-resistant, black oxide, stainless steel mounting screws. Stainless steel universal mounting ring for faceplate adjustment and 1/8' thick HT-805A silicone foam gasket with acrylic adhesive for water-tight seal.
	LAMP	For use with bi-pin MR16 lamps. Not for use with IR technology lamps. Halogen sourced by others.
	INSTALLATION	For use with 50W maximum lamp when installed into non-combustible materials or with 20W maximum lamp into combustible materials (Type Non IQ) (requires optional thermal protection).
	LENS	Heat-treated rectilinear lens provides wide lateral distribution and long forward throw.
	AIMING & CONTROL	Optional adjustable lamp bracket with up to 24° vertical aiming, captive thumb screw and quick release bracket to maintain optical alignment during re-lamping.
	FINISH	StarGuard, our 15-stage chromate-free process cleans and conversion coats aluminum components prior to application of Class 'A' TGIC polyester powder coating and is RoHS compliant. Powder coat or metal finish options available for brass material and metal finish option only for stainless steel material.
	WARRANTY	5-year limited warranty.
	CERTIFICATION & LISTING	ITL tested to IESNA LM-79. UL Listed. Certified to CAN/CSA/ANSI Standards. RoHS compliant. Suitable for indoor or outdoor use, in wet locations, and for installation in combustible materials (Type Non-IC) and within 4' of the ground. IP65 Rated. Made in the USA with sustainable processes.

