

DATE: \_\_\_\_\_ PROJECT: \_\_\_\_\_ TYPE: \_\_\_\_\_

CATALOG NUMBER LOGIC:



*\*Designed for use with LED transformer. Requires magnetic low voltage dimmer.*

*\*\*Please see Adjust-e-Lume photometry to determine desired intensity.*

*\*\*\*The 360SL cost is already included in the price of UPM, UPM dual, and Power Canopy.*

**CATALOG NUMBER LOGIC**

Example: B - DS - LED - e64 - SP - A7 - BZP - 12 - 11 - A - 360SL

**MATERIAL**

(Blank) - Aluminum B - Brass S - Stainless Steel

**SERIES**

DS - Delta Star

**SOURCE**

LED - with Integral Dimming Driver (25W min. load when dimmed)\*

**LED TYPE**

e64 - 7W LED/2700K	e79 - 7W LED/2700K 90CRI
e65 - 7W LED/3000K	e80 - 7W LED/3000K 90CRI
e66 - 7W LED/4000K	e81 - 7W LED/3500K 80CRI
e74 - 7W LED/Amber	

**OPTICS**

NSP - Narrow Spot (13°)	MFL - Medium Flood (23°)
SP - Spot (16°)	WFL - Wide Flood (31°)

**ADJUST-E-LUME® OUTPUT INTENSITY\*\***

A9 (Standard), A8, A7, A6, A5, A4, A3, A2, A1

**FINISH (See page 2 for full-color swatches)**

Standard Finishes (BZP, BZW, BLP, BLW, WHP, WHW, SAP, VER)

Premium Finish (ABP, AMG, AQW, BCM, BGE, BPP, CAP, CMG, CRM, HUG, NBP, OCP, RMG, SDS, SMG, TXF, WCP, WIR)

Also available in RAL Finishes

Brass Finishes (MAC, POL, MIT)

Stainless Steel Finishes (MAC, POL)

**LENS TYPE**

12 - Soft Focus 13 - Rectilinear

**SHIELDING**

11 - Honeycomb Baffle

**CAP STYLE**

A - 45°  
 B - 90°  
 C - Flush Lens  
 D - 45° Less Weephole (Interior use only)  
 E - 90° Less Weephole (Interior use only)  
 F - 90° with Flush Lens

**OPTION**

360SL - Knuckle Mounting System\*\*\*

**MOD OPTIONS**

5 - 5 Ft Leads  
 25 - 25 Ft Leads

DATE: \_\_\_\_\_ PROJECT: \_\_\_\_\_ TYPE: \_\_\_\_\_

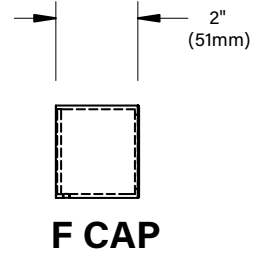
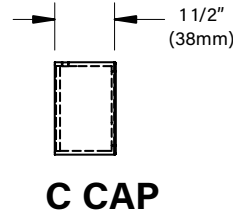
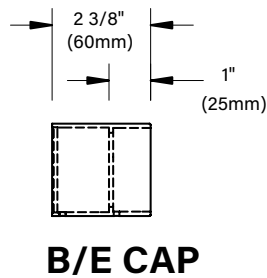
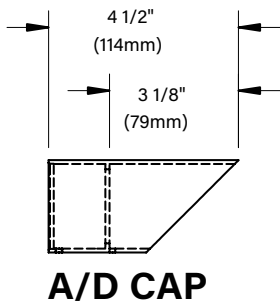
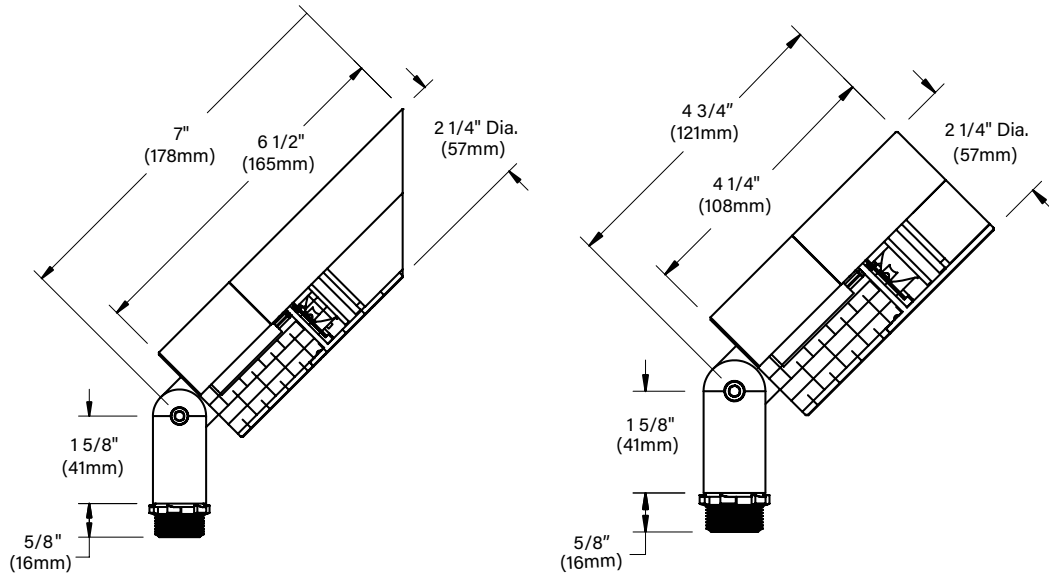

**STANDARD FINISHES**



**PREMIUM FINISHES**

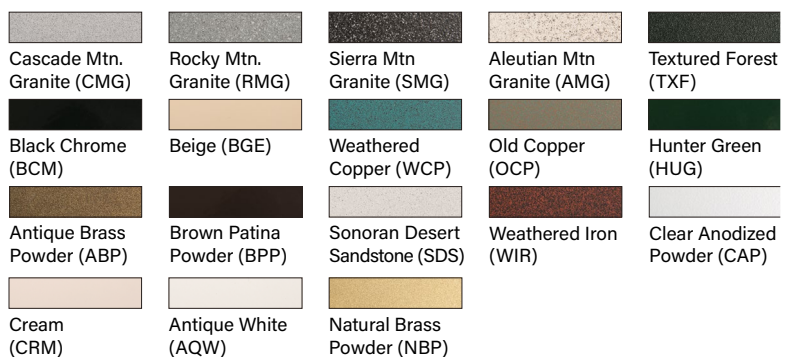

[Click Here](#) to view larger, full-color swatches of all available finishes on our website.

DATE: \_\_\_\_\_ PROJECT: \_\_\_\_\_ TYPE: \_\_\_\_\_

ACCESSORIES (Configure separately)

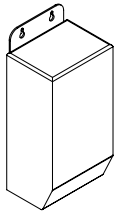

TR Series

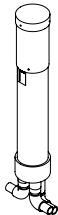

Power Pipe

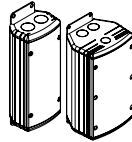

UPMRM

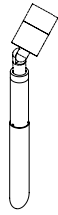

Power Pipe

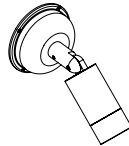

Power Canopy

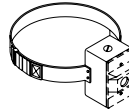

Tree Strap



Stems

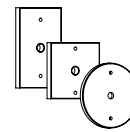

Canopies

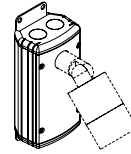

UPM

SPECIFICATIONS

ELECTRICAL	<p>WATTAGE WIRING REMOTE TRANSFORMER</p>	<p>7W LED XLPE, 18GA,150C, 600V, rated and certified to UL3321. For use with 12VAC remote transformer or magnetic transformers only. B-K Lighting cannot guarantee performance with third party manufacturers' transformers.</p>
PHYSICAL	<p>MATERIALS BODY KNUCKLE  CAP LENS  LED  DIMMING  ADJUST-E-LUME  OPTICS  HARDWARE  FINISH  WARRANTY CERTIFICATION &amp; LISTING</p>	<p>Furnished in copper-free aluminum (6061-T6), brass (360) or stainless steel (304). Unibody design with enclosed, water-proof wireway and integral heat sink is fully machined from solid billet. LOCK Knuckle is integral to the body and features an interior taper machined from solid billet and a second, reverse angle taper allowing full 180° vertical adjustment without the use of aim-limiting serrated teeth. High temperature, silicone 'O' Ring provides water-tight seal and compressive resistance to maintain fixture position. Design withstands 73 lbs. static load prior to movement for optical alignment with a 1/2" pipe thread for mounting. Optional 360SL provides biaxial source control with 360° horizontal rotation in addition to vertical adjustment. Fully machined and accommodates two (2) lens or louver media. Shock-resistant, tempered glass lens is factory adhered to fixture cap and provides hermetically sealed optical compartment. Integrated solid state system and modular design with electrical disconnects allow for easy field upgrade and maintenance. High power, forward throw source complies with ANSI C78.377 binning requirements and exceeds ENERGY STAR® lumen maintenance requirements. LM-80 certified components. Integral, constant current driver. 12VAC/VDC input. 50/60Hz. Proprietary input control scheme achieves power factor correction and eliminates inrush current (limited to &lt;250mA non-dimming). Output, overvoltage, open-circuit, and short circuit protected. Conforms to Safety Std. C22.2 No. 250.13-12. Line voltage dimmable via magnetic low voltage dimmer with dedicated neutral conductor. Remote magnetic transformer with LED loads should be loaded to 25% of the transformer VA (watts) rated value. Integral electronics allow for dynamic lumen response at the individual fixture. Indexed (100% to 25% nom.) lumen output. Maintains output at desired level or may be changed. Specify factory preset output intensity. Interchangeable OPTIKIT modules permit optical field changes. Color-code: Narrow Spot (NSP) = red; Spot (SP) = green; Medium Flood (MFL) = yellow; Wide Flood (WFL) = blue. Tamper-resistant, stainless steel hardware. LOCK aiming screw is black oxide treated for additional corrosion resistance. StarGuard, our 15-stage chromate-free process cleans and conversion coats aluminum components prior to application of Class 'A' TGIC polyester powder coating and is RoHS compliant. Powder coat or metal finish options available for brass material and metal finish option only for stainless steel material. 5-year limited warranty. ITL tested to IESNA LM-79. UL Listed. Certified to CAN/CSA/ANSI Standards. RoHS compliant. Suitable for indoor or outdoor use, in wet locations, and for installation within 4' of the ground. IP66 Rated. Made in the USA with sustainable processes.</p>



# LAMP & DRIVER DATA (e64, e65, e66, e74)

DATE:	PROJECT:	TYPE:
-------	----------	-------

DRIVER DATA	Input Volts	InRush Current	Operating	Dimmable	Operation Ambient Temperature
	12VAC/DC 50/60Hz	<250mA (non-dimmed)	700mA	Magnetic Low Voltage Dimmer	-22°F-194°F (-30°C - 90°C)

LM79 DATA				L70 DATA		OPTICAL DATA			
BK No.	CCT (Typ.)	CRI (Typ.)	Input Watts (Typ.)	Minimum Rated Life (hrs.) 70% of initial lumens (L <sub>70</sub> )		Angle	CBCP	Delivered Lumens	Multiplier
e64	2700K	80	7	50,000		13°	5993	456	0.87
	2700K	80	7	50,000		16°	4546	445	0.87
	2700K	80	7	50,000		23°	1726	397	0.87
	2700K	80	7	50,000		31°	1131	399	0.87
e65	3000K	80	7	50,000		13°	6131	466	0.89
	3000K	80	7	50,000		16°	4650	455	0.89
	3000K	80	7	50,000		23°	1766	406	0.89
	3000K	80	7	50,000		31°	1157	409	0.89
e66	4000K	80	7	50,000		13°	6889	524	
	4000K	80	7	50,000		16°	5225	511	
	4000K	80	7	50,000		23°	1984	456	
	4000K	80	7	50,000		31°	1300	459	
e74	Amber	80	7	50,000		13°	3,927	299	0.57
	Amber	80	7	50,000		16°	2,978	291	0.57
	Amber	80	7	50,000		23°	1,131	260	0.57
	Amber	80	7	50,000		31°	741	262	0.57

## OPTICS

Optic	Angle
NSP - Narrow Spot	13°
SP - Spot	16°
MFL - Medium Flood	23°
WFL - Wide Flood	31°

**B-K LIGHTING**

MADE IN THE USA

559.438.5800 | INFO@BKLIGHTING.COM | BKLIGHTING.COM

THIS DOCUMENT CONTAINS PROPRIETARY INFORMATION OF B-K LIGHTING, INC. AND ITS RECEIPT OR POSSESSION DOES NOT CONVEY ANY RIGHTS TO REPRODUCE, DISCLOSE ITS CONTENTS, OR TO MANUFACTURE, USE OR SELL ANYTHING IT MAY DESCRIBE. REPRODUCTION, DISCLOSURE OR USE WITHOUT SPECIFIC WRITTEN AUTHORIZATION OF B-K LIGHTING, INC. IS STRICTLY FORBIDDEN.