

# CANOPY

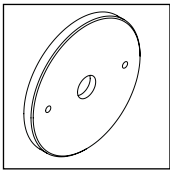

## Standard Installation



Warning



Low Voltage

**NEEDED FOR INSTALLATION:**

➤ 5/32" & 5/64" Allen wrench

🔌 Waterproof Wire Connectors

By Others

### INSTRUCTIONS PERTAINING TO A RISK OF FIRE, OR INJURY TO PERSONS IMPORTANT SAFETY INSTRUCTIONS

Lighted lamp is HOT!

**WARNING** - To reduce the risk of FIRE OR INJURY TO PERSONS: Turn off/unplug and allow to cool before replacing lamp. Lamp gets HOT quickly! Contact only switch/plug when turning on.

Do not touch hot lens, guard, or enclosure (see diagram/picture).

Keep lamp away from materials that may burn. Do not touch the lamp at any time. Use a soft cloth. Oil from skin may damage lamp. Do not operate the luminaire fitting with a missing or damaged shield.

**SAVE THESE INSTRUCTIONS**

### IMPORTANT SAFETY INFORMATION - READ, FOLLOW, AND SAVE ALL SAFETY AND INSTALLATION INSTRUCTIONS

- Product must be installed by a qualified person in a manner consistent with its intended use and in compliance with the National Electrical Code, Canadian Electrical Code, and all Local and Provincial Codes.
- Follow product label information and instructions.
- Qualified Personnel must perform all servicing or relamping of this product.
- Before wiring to power supply and during servicing or relamping, turn off power at fuse or circuit breaker before service.
- The use of accessory equipment not recommended by the manufacturer or installed contrary to instructions may cause an unsafe condition. The use of damaged components may cause an unsafe condition and void product warranty.
- Do not block light emanating from product in whole or part, as this may cause an unsafe condition.
- Never operate the fixture with missing or damaged lens. Lens must be cleaned on regular basis.
- Entire fixture may become extremely hot. Do not touch hot lens or fixture body. Do not touch the lamp at any time. Use a clean, dry, soft cloth to handle the lamp. Oil from skin may damage the lamp and cause it to rupture.
- Replace lamp only with correct wattage and type of lamp marked on fixture label.
- All gaskets, o-rings and sealing surfaces must be kept clean during installation and service; failure to do this may cause an unsafe condition and void product warranty.

### IMPORTANT LISTINGS AND CERTIFICATIONS

• Suitable for wet locations

• Additionally suitable for mounting within 4 ft. of the ground

Please refer to the low voltage design guide at [www.bklighting.com/lvguide](http://www.bklighting.com/lvguide) before installation for proper wire selection.

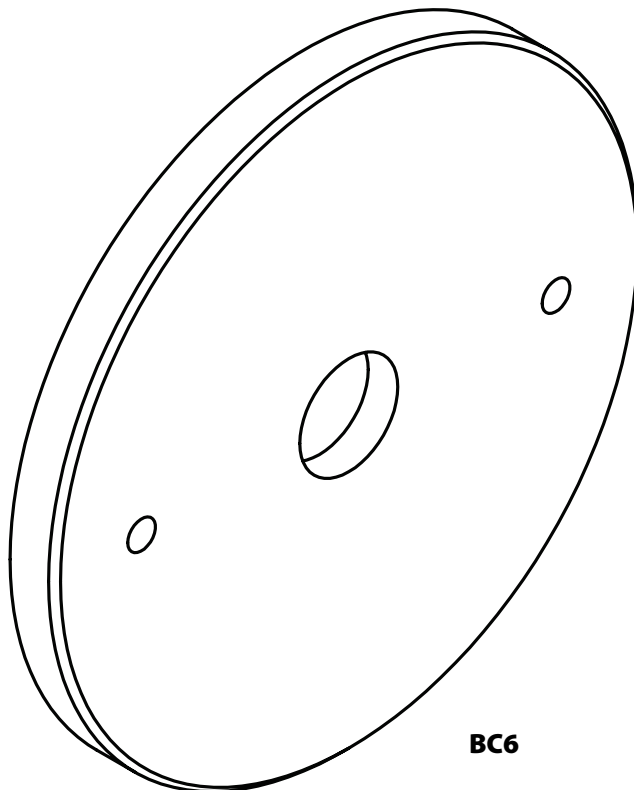

BC6

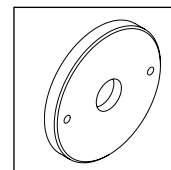

BC7

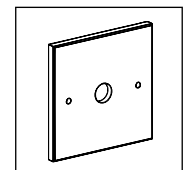

BC8

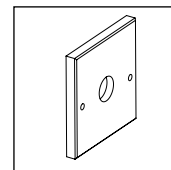

BC9

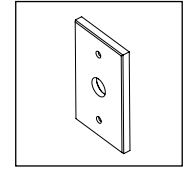

BC10

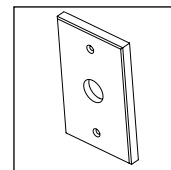

BC11

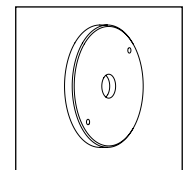

BC12

### IMPORTANT SAFETY INFORMATION - READ, FOLLOW, AND SAVE THESE INSTALLATION INSTRUCTIONS

**B-K LIGHTING**

40429 Brickyard Drive • Madera, CA 93636 • USA  
559.438.5800 • FAX 559.438.5900  
[www.bklighting.com](http://www.bklighting.com) • [info@bklighting.com](mailto:info@bklighting.com)

RELEASE DATE  
4-27-18

REFERENCE NUMBER  
INS001389

THIS DOCUMENT CONTAINS PROPRIETARY INFORMATION OF B-K LIGHTING, INC. AND ITS RECEIPT OR POSSESSION DOES NOT CONVEY ANY RIGHTS TO REPRODUCE, DISCLOSE ITS CONTENTS, OR TO MANUFACTURE, USE OR SELL ANYTHING IT MAY DESCRIBE. REPRODUCTION, DISCLOSURE OR USE WITHOUT SPECIFIC WRITTEN AUTHORIZATION OF B-K LIGHTING, INC. IS STRICTLY FORBIDDEN.

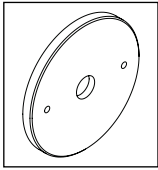

# CANOPY

## Standard Installation

### Phase 1 - Rough In

Installation of Back box by Others

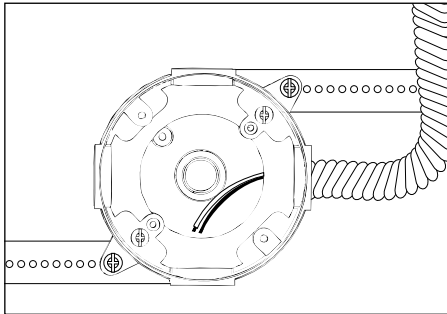

#### Additional Info

- Please follow National and Local electrical codes for your area.
- Suitable for through wire
- Suitable for installation into combustible materials.
- Rated for 90° C.
- Junction box, universal mounting ring screws, box mounting hardware and gaskets (By Others)

1. Install Conduit (by others) to be used with this product.
2. Install junction box (By Others) so that front face is flush with finished wall or ceiling. **Seal building envelope as per NEC.**
3. Connect box to conduit and pull wires for low voltage connections (See Wiring diagram).

### Phase 2 - Fixture Installation

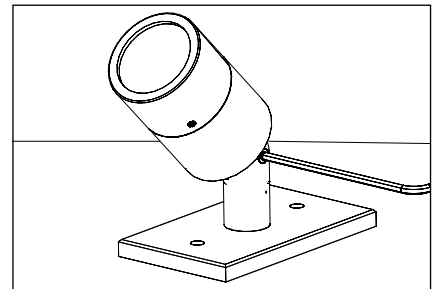
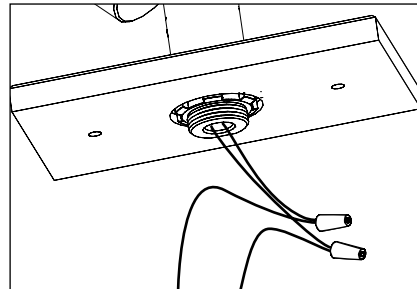
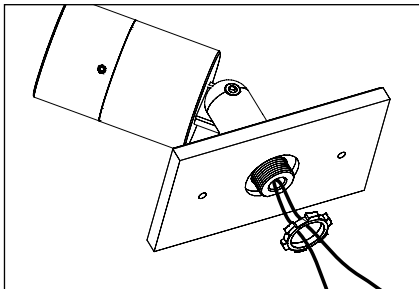

1. Mount knuckle onto suitable enclosure according to designed lighting plan.
2. Secure 1/2" NPS stem to mounting option. Secure with provided locknut if applicable.
3. Make watertight connections from remote 12V transformer to fixture leads using waterproof wire connectors (By Others).
4. Mount canopy with hardware provided or use appropriate hardware best suited for architecture structure. **Seal building envelope as per NEC.**

### Phase 3 - Finish Installation of Canopy with provided Universal Ring.

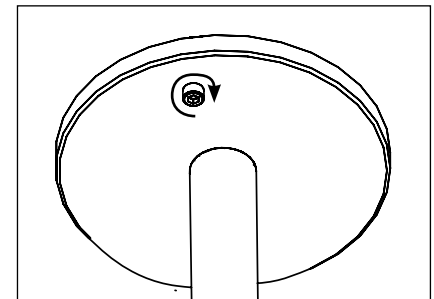
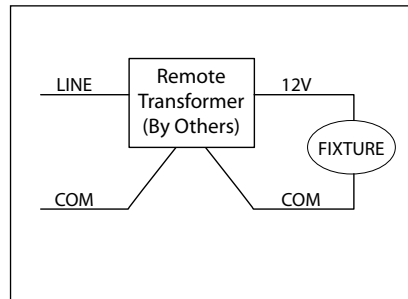
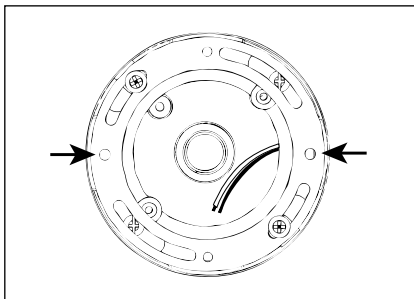

1. Install universal mounting ring (supplied with canopy) onto installed junction box using supplied #10-24 screws. Align faceplate mounting holes to final mounting position.
2. Make watertight connections from remote transformer to fixture leads using waterproof wire connectors (By Others). **See wiring diagram.**
3. Mount fixture using two (2) #10-24 hex screw to installed back box. **Seal building envelope as per NEC. Do not over tighten.**

**IMPORTANT SAFETY INFORMATION LISTED ON REVERSE  
READ, FOLLOW, AND SAVE ALL SAFETY AND INSTALLATION INSTRUCTIONS**



# B-K LIGHTING

40429 Brickyard Drive • Madera, CA 93636 • USA  
559.438.5800 • FAX 559.438.5900  
www.bklighting.com • info@bklighting.com

RELEASE DATE  
4-27-18

REFERENCE NUMBER  
INS001389