

DATE:	PROJECT:	TYPE:
-------	----------	-------

CATALOG NUMBER LOGIC:

**CATALOG NUMBER LOGIC**

Example: PM3RM - TSC-24 - 010 - BLP - MT - MB

MATERIAL

Aluminum

SERIES

PM3RM - Universal Power Module 3 Remote

MOUNTING

TSC-Length - Tree Strap with Safety Cable (Specify adjustable strap length) 18" Standard Min.

CONTROL

010 - 0-10V Wired Installation*

BT - Bluetooth (See requirements)**

FINISH (See page 2 for full-color swatches)

Standard Finishes (BZP, BZW, BLP, BLW, WHP, WHW, SAP, VER)

Premium Finish (ABP, AMG, AQW, BCM, BGE, BPP, CAP, CMG, CRM, HUG, NBP, OCP, RMG, SDS, SMG, TXF, WCP, WIR)

(Also available in RAL Finishes. See submittal SUB-1439-00)

INPUT VOLTAGE

MT - 120-277 VAC

OPTIONS

MB - Mounting Brackets

Requires 2 sets of 0-10V controls. Sold separately.**Bluetooth control system requirements. For use with iPod Touch 5 or later, Mini iPad, iPad3 (2012) or later or iPhone 4S or later.*

DATE: _____ PROJECT: _____ TYPE: _____

TOP VIEW

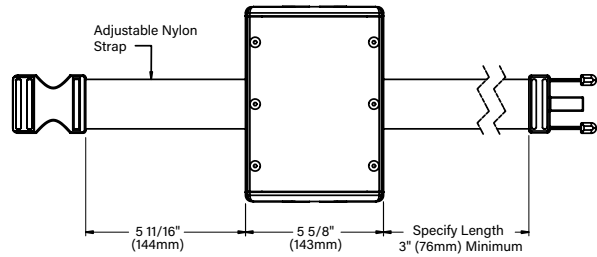

END VIEW

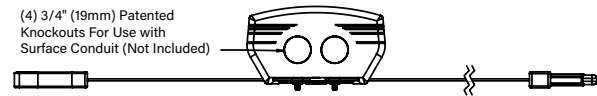

SAFETY CABLE

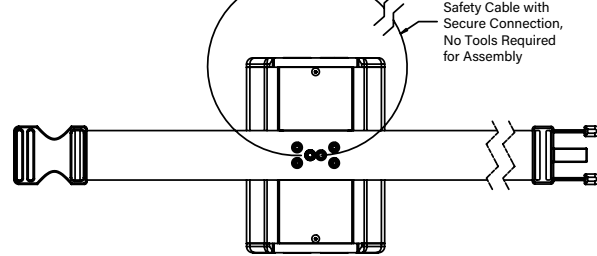

⚠ REMOTE WIRING

LED Driver

Remote driver installations require inter-connected wiring between the LED and driver (by others). Drivers have specific wiring requirements between these components. Driver manufacturers regularly recommend the following wiring details for such installations:

- Do not exceed 50 foot overall wiring distance using 12 gauge copper wire.

Failure to comply with specific wiring requirements will void product warranty.

OPTIONAL MOUNTING BRACKET

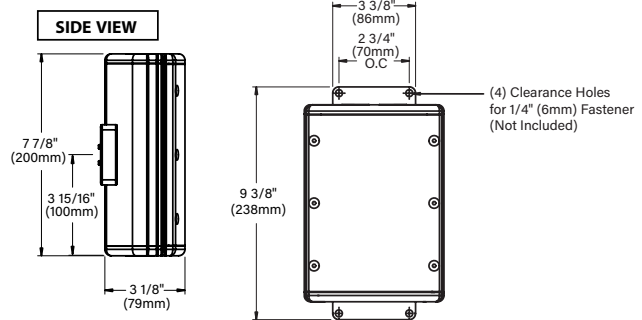

0-10V WIRED CONTROL

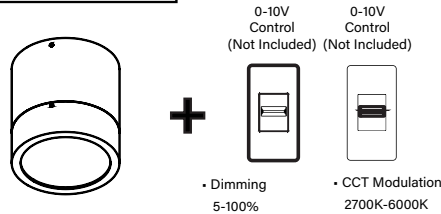

IOS DEVICE CONTROL

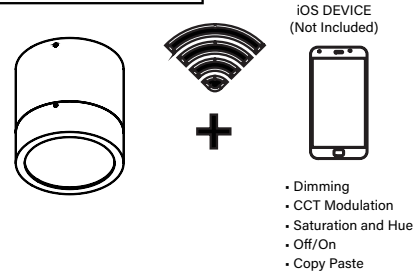

STANDARD FINISHES



PREMIUM FINISHES

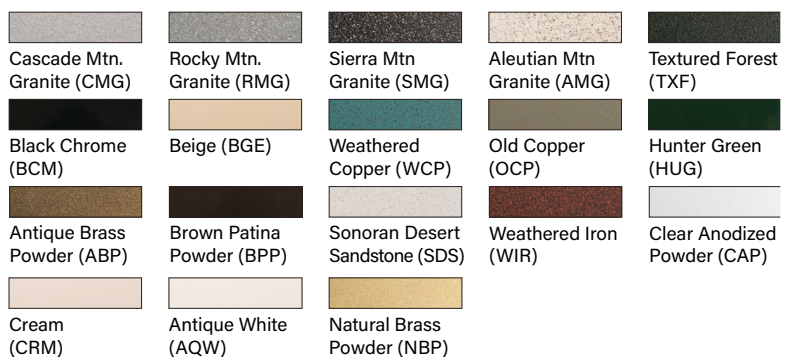



[Click Here](#) to view larger, full-color swatches of all available finishes on our website.

DATE:	PROJECT:	TYPE:
-------	----------	-------

ACCESSORIES (Configure separately)

SPECIFICATIONS

Electrical	INSPIRATION (BLUETOOTH WIRELESS TECHNOLOGY)	Wireless communication system creates dynamic lumen response at the individual fixture. Indexed (100% to 5% nom.) lumen output. Maintains output at desired level or may be changed as conditions require via exclusive mobile application. App available at the Apple App® Store. CCT modulation between 1650K through 4000K. Full saturation and hue control enables selection of any single color point off the Planckian curve for dynamic full color output. A copy/paste function permits replication of the current selection to other modules within the wireless network. Wireless control up to 5 feet.
	BLUETOOTH CONNECTIVITY REQUIREMENTS	iOS device (by others) with Inspiration Control System app is required for wireless Bluetooth® control. Works with iPhone® (4S or newer); iPad® (3rd generation or newer); iPad mini®; iPad Air®; iPod® Touch (5th generation or newer).
	0-10V WIRED CONTROL	Requires two (2) sets of 0-10V industry wired controls wired direct to the fixture. One provides CCT modulation between 1650K through 8000K in 1% increments. The second enables 5-100% dimming in 1% increments. iOS device may also be utilized to select a single color point off the Planckian curve for dynamic full color output with the remaining functions enabled by the 0-10V controls.
	DRIVER	One (1) 1.75A, Class A (sound), Class II (isolation) driver. 120VAC (nominal) primary input voltage. 50/60Hz. >0.90 Power Factor, 20% THD (nominal at 120VAC full load). Output over-voltage, over-current, and short circuit protection.
PHYSICAL	TREE INSTALLATION	Tree Strap mounting system facilitates non-invasive installation. Adjustable nylon strap is mold and mildew resistant and will not hinder tree growth. Stainless steel safety cable maintains UPM mounting when nylon strap is disengaged.
	HOUSING	Copper free, aluminum extrusion with die cast end caps. Surface mounted with flow through back channel to prevent water and debris collection. Machined aluminum cover with countersunk holes for flush hardware installation. Tamper-resistant, captive, black oxide stainless steel mounting screws. Front access for ease of installation and inspection. Two (2) 1/2" NPT female conduit entries per end cap for through wiring.
	INSTALLATION TETHER	Stainless steel cable with integral loop allows cover to temporarily suspend from housing during installation to simplify wire connection and component attachment.
	PATENTED KNOCKOUTS	Four (4) 3/4" NPT, machined aluminum knockouts. High temperature, silicone 'O' Ring for water-tight seal. Patented design allows knockout to be reinserted without compromising seal integrity.
	FINISH	StarGuard, our 15-stage, chromate-free process cleans and conversion coats aluminum components prior to application of Class 'A' TGIC polyester powder coating and is RoHS compliant. Finish to match fixture. (specified separately).
	WARRANTY CERTIFICATION & LISTING	5-year limited warranty. Certified to CAN/CSA/ANSI Standards. UL Listed. NEMA 4X / IP66 Rated Enclosure. RoHs compliant. Made in USA with sustainable processes.
  		

B-K LIGHTING

MADE IN THE USA

559.438.5800 | INFO@BKLIGHTING.COM | BKLIGHTING.COM

DATE:	PROJECT:	TYPE:
-------	----------	-------

CATALOG NUMBER LOGIC:

**CATALOG NUMBER LOGIC**

Example: PM3RM - SM - 010 - BLP - MT

MATERIAL

Aluminum

SERIES

PM3RM - Universal Power Module 3 Remote

MOUNTING

SM - Surface Mount

CONTROL

010 - 0-10V Wired Installation*

BT - Bluetooth (See requirements)**

FINISH (See page 2 for full-color swatches)

Standard Finishes (BZP, BZW, BLP, BLW, WHP, WHW, SAP, VER)

Premium Finish (ABP, AMG, AQW, BCM, BGE, BPP, CAP, CMG, CRM, HUG, NBP, OCP, RMG, SDS, SMG, TXF, WCP, WIR)

(Also available in RAL Finishes. See submittal SUB-1439-00)

INPUT VOLTAGE

MT - 120-277 VAC

Requires 2 sets of 0-10V controls. Sold separately.**Bluetooth control system requirements. For use with iPod Touch 5 or later, Mini iPad, iPad3 (2012) or later or iPhone 4S or later.*

DATE:

PROJECT:

TYPE:

⚠ REMOTE WIRING

LED Driver

Remote driver installations require inter-connected wiring between the LED and driver (by others). Drivers have specific wiring requirements between these components. Driver manufacturers regularly recommend the following wiring details for such installations:

- Do not exceed 50 foot overall wiring distance using 12 gauge copper wire.

Failure to comply with specific wiring requirements will void product warranty.

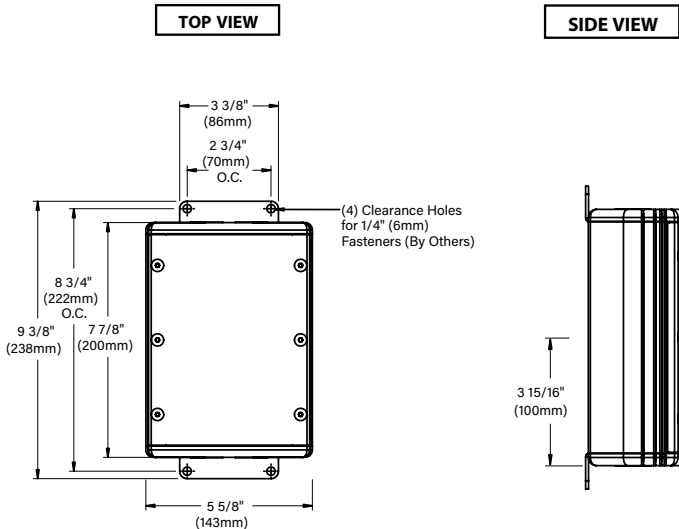

END VIEW

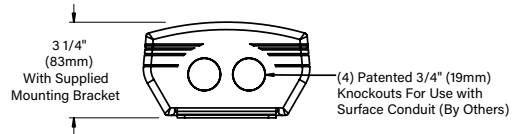

0-10V WIRED CONTROL

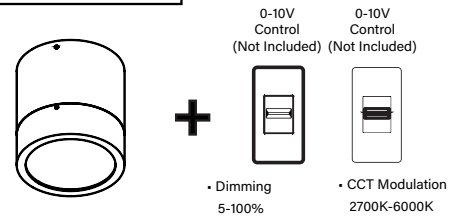

IOS DEVICE CONTROL

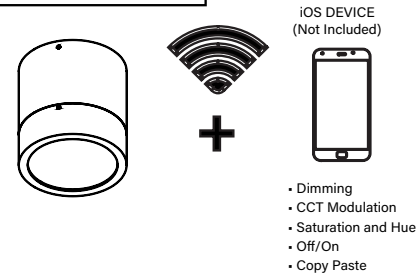

STANDARD FINISHES



PREMIUM FINISHES

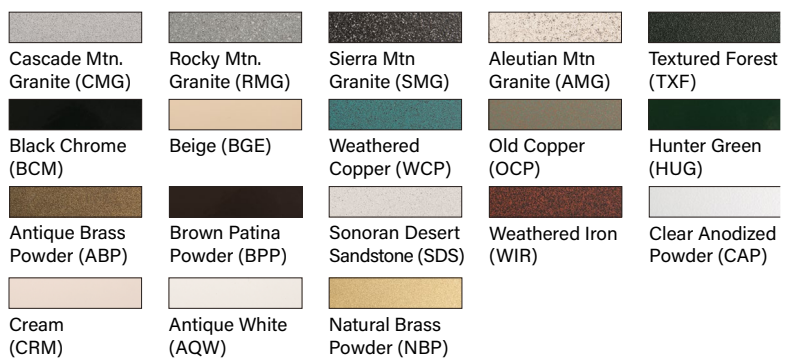



[Click Here](#) to view larger, full-color swatches of all available finishes on our website.

DATE:	PROJECT:	TYPE:
-------	----------	-------

ACCESSORIES (Configure separately)

SPECIFICATIONS

Electrical	INSPIRATION (BLUETOOTH WIRELESS TECHNOLOGY)	Wireless communication system creates dynamic lumen response at the individual fixture. Indexed (100% to 5% nom.) lumen output. Maintains output at desired level or may be changed as conditions require via exclusive mobile application. App available at the Apple App® Store. CCT modulation between 1650K through 4000K. Full saturation and hue control enables selection of any single color point off the Planckian curve for dynamic full color output. A copy/paste function permits replication of the current selection to other modules within the wireless network. Wireless control up to 5 feet.
	BLUETOOTH CONNECTIVITY REQUIREMENTS	iOS device (by others) with Inspiration Control System app is required for wireless Bluetooth® control. Works with iPhone® (4S or newer); iPad® (3rd generation or newer); iPad mini®; iPad Air®; iPod® Touch (5th generation or newer).
	0-10V WIRED CONTROL	Requires two (2) sets of 0-10V industry wired controls wired direct to the fixture. One provides CCT modulation between 1650K through 8000K in 1% increments. The second enables 5-100% dimming in 1% increments. iOS device may also be utilized to select a single color point off the Planckian curve for dynamic full color output with the remaining functions enabled by the 0-10V controls.
	DRIVER	One (1) 1.75A, Class A (sound), Class II (isolation) driver. 120VAC (nominal) primary input voltage. 50/60Hz. >0.90 Power Factor, 20% THD (nominal at 120VAC full load). Output over-voltage, over-current, and short circuit protection.
PHYSICAL	SURFACE MOUNT	For use with side entry, surface conduits. Stainless steel mounting brackets provide for direct anchor to architectural surfaces in any orientation.
	HOUSING	Copper free, aluminum extrusion with die cast end caps. Surface mounted with flow through back channel to prevent water and debris collection. Machined aluminum cover with countersunk holes for flush hardware installation. Tamper-resistant, captive, black oxide stainless steel mounting screws. Front access for ease of installation and inspection. Two (2) 3/4" NPT female conduit entries per end cap for through wiring.
	INSTALLATION TETHER	Stainless steel cable with integral loop allows cover to temporarily suspend from housing during installation to simplify wire connection and component attachment.
	PATENTED KNOCKOUTS	Four (4) 3/4" NPT, machined aluminum knockouts. High temperature, silicone 'O' Ring for water-tight seal. Patented design allows knockout to be reinserted without compromising seal integrity.
	FINISH	StarGuard, our 15-stage, chromate-free process cleans and conversion coats aluminum components prior to application of Class 'A' TGIC polyester powder coating and is RoHS compliant. Finish to match fixture. (specified separately).
	WARRANTY	5-year limited warranty.
CERTIFICATION & LISTING	Certified to CAN/CSA/ANSI Standards. UL Listed. NEMA 4X / IP66 Rated Enclosure. RoHS compliant. Made in USA with sustainable processes.	
  		

B-K LIGHTING

MADE IN THE USA

559.438.5800 | INFO@BKLIGHTING.COM | BKLIGHTING.COM

DATE:	PROJECT:	TYPE:
-------	----------	-------

CATALOG NUMBER LOGIC:

**CATALOG NUMBER LOGIC**

Example: PM3RM - CR - 010 - BLP - MT - MB

MATERIAL

Aluminum

SERIES

PM3RM - Universal Power Module 3 Remote

MOUNTING

CR - Round Camlock Canopy (Recessed Junction Box)

CONTROL

010 - 0-10V Wired Installation*

BT - Bluetooth (See requirements)**

FINISH (See page 2 for full-color swatches)

Standard Finishes (BZP, BZW, BLP, BLW, WHP, WHW, SAP, VER)

Premium Finish (ABP, AMG, AQW, BCM, BGE, BPP, CAP, CMG, CRM, HUG, NBP, OCP, RMG, SDS, SMG, TXF, WCP, WIR)

(Also available in RAL Finishes. See submittal SUB-1439-00)

INPUT VOLTAGE

MT - 120-277 VAC

OPTIONS

MB - Mounting Brackets

Requires 2 sets of 0-10V controls. Sold separately.**Bluetooth control system requirements. For use with iPod Touch 5 or later, Mini iPad, iPad3 (2012) or later or iPhone 4S or later.*

DATE: _____ PROJECT: _____ TYPE: _____

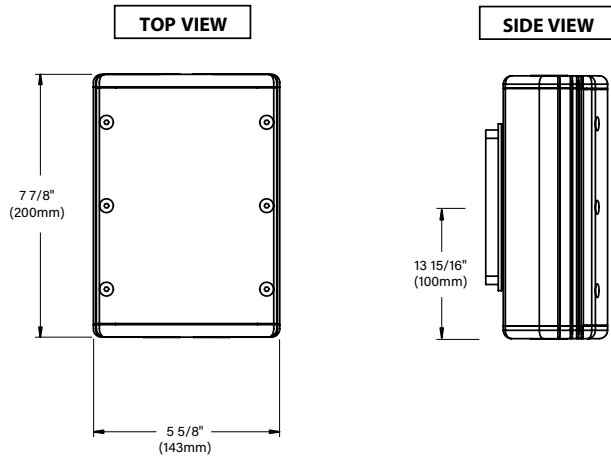

⚠ REMOTE WIRING

LED Driver

Remote driver installations require inter-connected wiring between the LED and driver (by others). Drivers have specific wiring requirements between these components. Driver manufacturers regularly recommend the following wiring details for such installations:

- Do not exceed 50 foot overall wiring distance using 12 gauge copper wire.

Failure to comply with specific wiring requirements will void product warranty.

ROUND CAMLOCK™ CANOPY

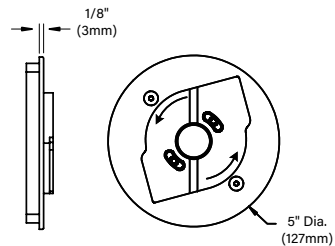
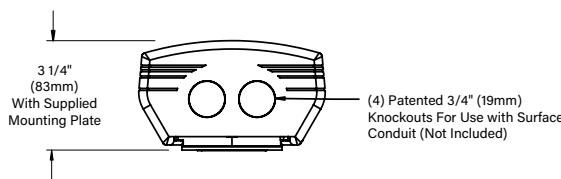

0-10V WIRED CONTROL

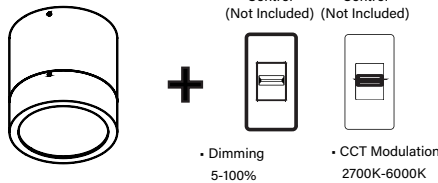

IOS DEVICE CONTROL

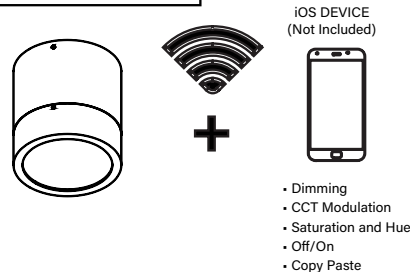

STANDARD FINISHES



PREMIUM FINISHES

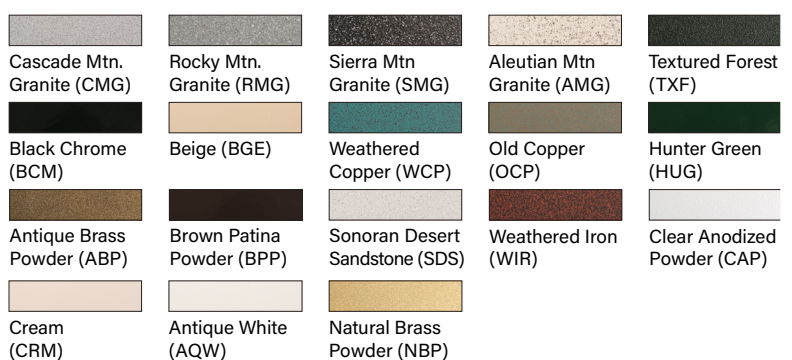



[Click Here](#) to view larger, full-color swatches of all available finishes on our website.

DATE:	PROJECT:	TYPE:
-------	----------	-------

ACCESSORIES (Configure separately)

SPECIFICATIONS

Electrical	INSPIRATION (BLUETOOTH WIRELESS TECHNOLOGY)	Wireless communication system creates dynamic lumen response at the individual fixture. Indexed (100% to 5% nom.) lumen output. Maintains output at desired level or may be changed as conditions require via exclusive mobile application. App available at the Apple App® Store. CCT modulation between 1650K through 4000K. Full saturation and hue control enables selection of any single color point off the Planckian curve for dynamic full color output. A copy/paste function permits replication of the current selection to other modules within the wireless network. Wireless control up to 5 feet.
	BLUETOOTH CONNECTIVITY REQUIREMENTS	iOS device (by others) with Inspiration Control System app is required for wireless Bluetooth® control. Works with iPhone® (4S or newer); iPad® (3rd generation or newer); iPad mini®; iPad Air®; iPod® Touch (5th generation or newer).
	0-10V WIRED CONTROL	Requires two (2) sets of 0-10V industry wired controls wired direct to the fixture. One provides CCT modulation between 1650K through 8000K in 1% increments. The second enables 5-100% dimming in 1% increments. iOS device may also be utilized to select a single color point off the Planckian curve for dynamic full color output with the remaining functions enabled by the 0-10V controls.
	DRIVER	One (1) 1.75A, Class A (sound), Class II (isolation) driver. 120VAC (nominal) primary input voltage. 50/60Hz. >0.90 Power Factor, 20% THD (nominal at 120VAC full load). Output over-voltage, over-current, and short circuit protection.
PHYSICAL	ROUND CAMLOCK CANOPY (RECESSED JUNCTION BOX)	5" dia., machined aluminum construction. Includes stainless steel universal mounting ring for use with 4" octagonal junction box. Two (2) tamper-resistant, black oxide stainless steel mounting screws. 1/8" thick HT-805A silicone foam gasket for water-tight seal. Integral Camlock provides additional 30° adjustment for precision alignment of UPM regardless of junction box orientation. Integral wiper seal maintains water-tight integrity between UPM and junction box. Optional stainless steel mounting brackets may be specified to provide additional anchor to architectural surface.
	HOUSING	Copper free, aluminum extrusion with die cast end caps. Surface mounted with flow through back channel to prevent water and debris collection. Machined aluminum cover with countersunk holes for flush hardware installation. Tamper-resistant, captive, black oxide stainless steel mounting screws. Front access for ease of installation and inspection. Two (2) 3/4" NPT female conduit entries per end cap for through wiring.
	INSTALLATION TETHER	Stainless steel cable with integral loop allows cover to temporarily suspend from housing during installation to simplify wire connection and component attachment.
	PATENTED KNOCKOUTS	Four (4) 3/4" NPT, machined aluminum knockouts. High temperature, silicone 'O' Ring for water-tight seal. Patented design allows knockout to be reinserted without compromising seal integrity.
	FINISH	StarGuard, our 15-stage, chromate-free process cleans and conversion coats aluminum components prior to application of Class 'A' TGIC polyester powder coating and is RoHS compliant. Finish to match fixture. (specified separately).
	WARRANTY	5-year limited warranty.
	CERTIFICATION & LISTING	Certified to CAN/CSA/ANSI Standards. UL Listed. NEMA 4X / IP66 Rated Enclosure. RoHs compliant. Made in USA with sustainable processes.
  		

B-K LIGHTING

MADE IN THE USA

559.438.5800 | INFO@BKLIGHTING.COM | BKLIGHTING.COM

DATE:	PROJECT:	TYPE:
-------	----------	-------

CATALOG NUMBER LOGIC:

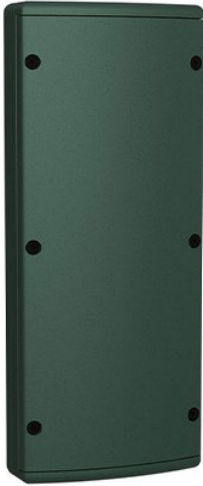
**CATALOG NUMBER LOGIC**

Example: PM3DRM - TSC-20 - 010 - BLP - MT - MB

MATERIAL

Aluminum

SERIES

PM3DRM - Universal Power Module 3 Dual Remote

MOUNTING

TSC-Length - Tree Strap with Safety Cable (Specify adjustable strap length) 18" Standard Min.

CONTROL

010 - 0-10V Wired Installation*

BT - Bluetooth (See requirements)**

FINISH (See page 2 for full-color swatches)

Standard Finishes (BZP, BZW, BLP, BLW, WHP, WHW, SAP, VER)

Premium Finish (ABP, AMG, AQW, BCM, BGE, BPP, CAP, CMG, CRM, HUG, NBP, OCP, RMG, SDS, SMG, TXF, WCP, WIR)

(Also available in RAL Finishes. See submittal SUB-1439-00)

INPUT VOLTAGE

MT - 120-277 VAC

OPTIONS

MB - Mounting Brackets

Requires 2 sets of 0-10V controls. Sold separately.**Bluetooth control system requirements. For use with iPod Touch 5 or later, Mini iPad, iPad3 (2012) or later or iPhone 4S or later.*

DATE: _____ PROJECT: _____ TYPE: _____

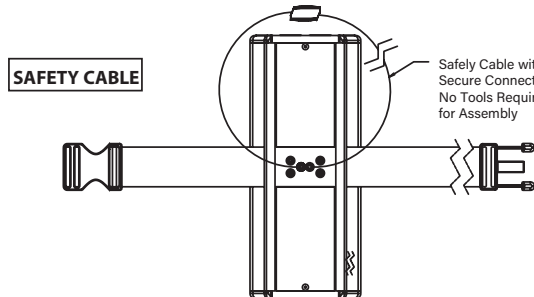
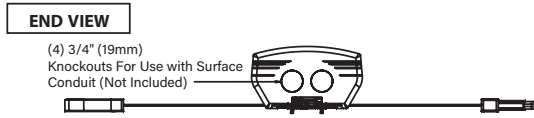
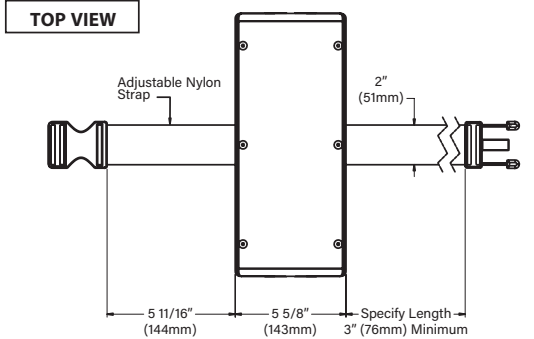

0-10V WIRED CONTROL

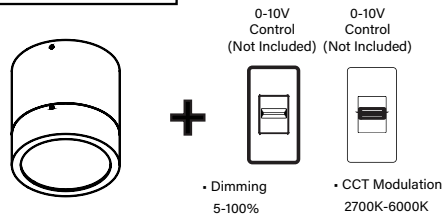

IOS DEVICE CONTROL

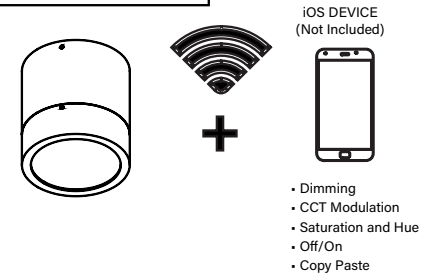

! REMOTE WIRING

LED Driver
 Remote driver installations require inter-connected wiring between the LED and driver (by others). Drivers have specific wiring requirements between these components. Driver manufacturers regularly recommend the following wiring details for such installations:

- Do not exceed 50 foot overall wiring distance using 12 gauge copper wire.

Failure to comply with specific wiring requirements will void product warranty.

SIDE VIEW

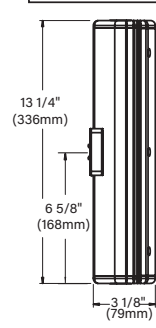

OPTIONAL MOUNTING BRACKET

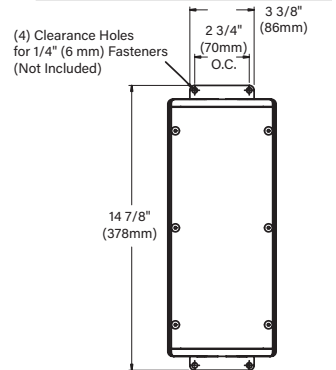

STANDARD FINISHES



PREMIUM FINISHES

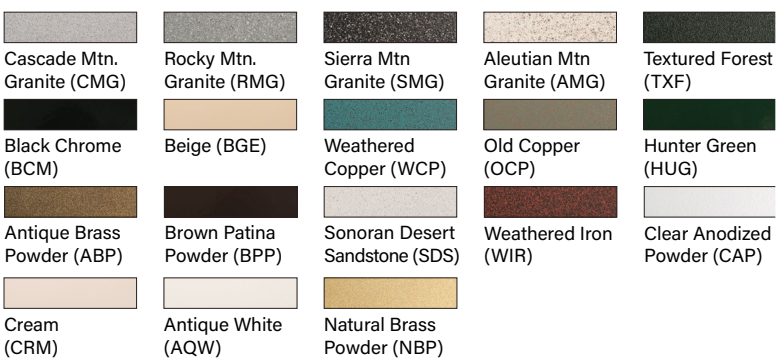



[Click Here](#) to view larger, full-color swatches of all available finishes on our website.

THIS DOCUMENT CONTAINS PROPRIETARY INFORMATION OF B-K LIGHTING, INC. AND ITS RECEIPT OR POSSESSION DOES NOT CONVEY ANY RIGHTS TO REPRODUCE, DISCLOSE ITS CONTENTS, OR TO MANUFACTURE, USE OR SELL ANYTHING IT MAY DESCRIBE. REPRODUCTION, DISCLOSURE OR USE WITHOUT SPECIFIC WRITTEN AUTHORIZATION OF B-K LIGHTING, INC. IS STRICTLY FORBIDDEN. 12/06/2022 SKU-1276 PM3DRM P1

DATE:	PROJECT:	TYPE:
-------	----------	-------

ACCESSORIES (Configure separately)

SPECIFICATIONS

Electrical	INSPIRATION (BLUETOOTH WIRELESS TECHNOLOGY)	Wireless communication system creates dynamic lumen response at the individual fixture. Indexed (100% to 5% nom.) lumen output. Maintains output at desired level or may be changed as conditions require via exclusive mobile application. App available at the Apple App® Store. CCT modulation between 1650K through 4000K. Full saturation and hue control enables selection of any single color point off the Planckian curve for dynamic full color output. A copy/paste function permits replication of the current selection to other modules within the wireless network. Wireless control up to 5 feet.
	BLUETOOTH CONNECTIVITY REQUIREMENTS	iOS device (by others) with Inspiration Control System app is required for wireless Bluetooth® control. Works with iPhone® (4S or newer); iPad® (3rd generation or newer); iPad mini®; iPad Air®; iPod® Touch (5th generation or newer).
	0-10V WIRED CONTROL	Requires two (2) sets of 0-10V industry wired controls wired direct to the fixture. One provides CCT modulation between 1650K through 8000K in 1% increments. The second enables 5-100% dimming in 1% increments. iOS device may also be utilized to select a single color point off the Planckian curve for dynamic full color output with the remaining functions enabled by the 0-10V controls.
	DRIVER	Two (2) 1.75A, Class A (sound), Class II (isolation) drivers. 120VAC (nominal) primary input voltage. 50/60Hz. >0.90 Power Factor, 20% THD (nominal at 120VAC full load). Output over-voltage, over-current, and short circuit protection.
PHYSICAL	TREE INSTALLATION	Tree Strap mounting system facilitates non-invasive installation. Adjustable nylon strap is mold and mildew resistant and will not hinder tree growth. Stainless steel safety cable maintains UPM mounting when nylon strap is disengaged.
	HOUSING	Copper free, aluminum extrusion with die cast end caps. Surface mounted with flow through back channel to prevent water and debris collection. Machined aluminum cover with countersunk holes for flush hardware installation. Tamper-resistant, captive, black oxide stainless steel mounting screws. Front access for ease of installation and inspection. Two (2) 1/2" NPT female conduit entries per end cap for through wiring.
	INSTALLATION TETHER	Stainless steel cable with integral loop allows cover to temporarily suspend from housing during installation to simplify wire connection and component attachment.
	PATENTED KNOCKOUTS	Four (4) 3/4" NPT, machined aluminum knockouts. High temperature, silicone 'O' Ring for water-tight seal. Patented design allows knockout to be reinserted without compromising seal integrity.
	FINISH	StarGuard, our 15-stage, chromate-free process cleans and conversion coats aluminum components prior to application of Class 'A' TGIC polyester powder coating and is RoHS compliant. Finish to match fixture. (specified separately).
	WARRANTY	5-year limited warranty.
CERTIFICATION & LISTING	Certified to CAN/CSA/ANSI Standards. UL Listed. NEMA 4X / IP66 Rated Enclosure. RoHs compliant. Made in USA with sustainable processes.	
  		

B-K LIGHTING
MADE IN THE USA

 559.438.5800 | INFO@BKLIGHTING.COM | BKLIGHTING.COM

ALPINE II - PM3DRM REMOTE DRIVER HOUSING (BLUETOOTH - SURFACE MOUNT) ORDER FIXTURES SEPARATELY.

DATE:	PROJECT:	TYPE:
-------	----------	-------

CATALOG NUMBER LOGIC:

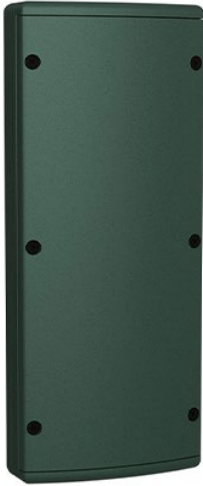

CATALOG NUMBER LOGIC

Example: PM3DRM - SM - 010 - BLP - MT

MATERIAL

Aluminum

SERIES

PM3DRM - Universal Power Module 3 Dual Remote

MOUNTING

SM - Surface Mount

CONTROL

010 - 0-10V Wired Installation*

BT - Bluetooth (See requirements)**

FINISH (See page 2 for full-color swatches)

Standard Finishes (BZP, BZW, BLP, BLW, WHP, WHW, SAP, VER)

Premium Finish (ABP, AMG, AQW, BCM, BGE, BPP, CAP, CMG, CRM, HUG, NBP, OCP, RMG, SDS, SMG, TXF, WCP, WIR)

(Also available in RAL Finishes. See submittal SUB-1439-00)

INPUT VOLTAGE

MT - 120-277 VAC

**Requires 2 sets of 0-10V controls. Sold separately.*

***Bluetooth control system requirements. For use with iPod Touch 5 or later, Mini iPad, iPad3 (2012) or later or iPhone 4S or later.*

DATE: _____ PROJECT: _____ TYPE: _____

⚠ REMOTE WIRING

LED Driver

Remote driver installations require inter-connected wiring between the LED and driver (by others). Drivers have specific wiring requirements between these components. Driver manufacturers regularly recommend the following wiring details for such installations:

- Do not exceed 50 foot overall wiring distance using 12 gauge copper wire.

Failure to comply with specific wiring requirements will void product warranty.

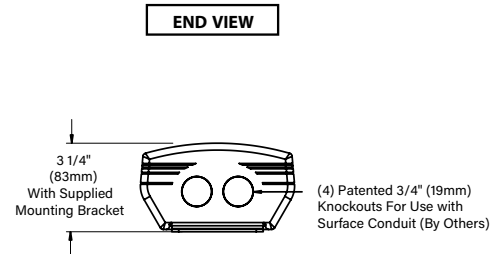
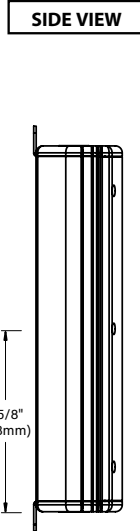
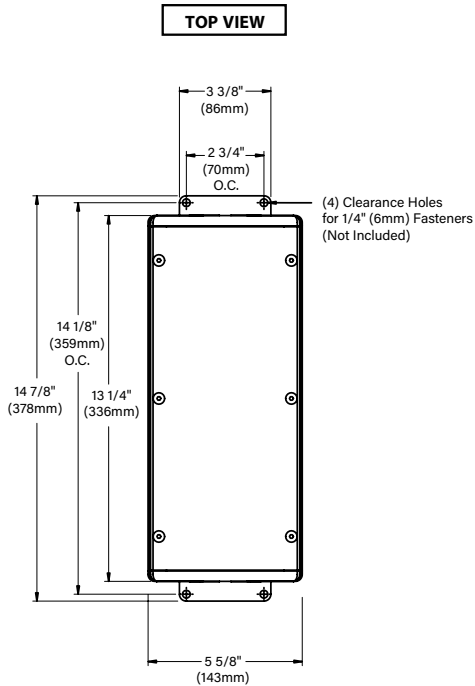

0-10V WIRED CONTROL

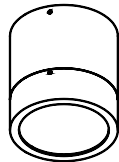

- +
- 0-10V Control (Not Included)
 - 0-10V Control (Not Included)
 - Dimming 5-100%
 - CCT Modulation 2700K-6000K

IOS DEVICE CONTROL

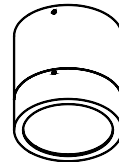

- +
- IOS DEVICE (Not Included)
 - Dimming
 - CCT Modulation
 - Saturation and Hue
 - Off/On
 - Copy Paste

STANDARD FINISHES



PREMIUM FINISHES

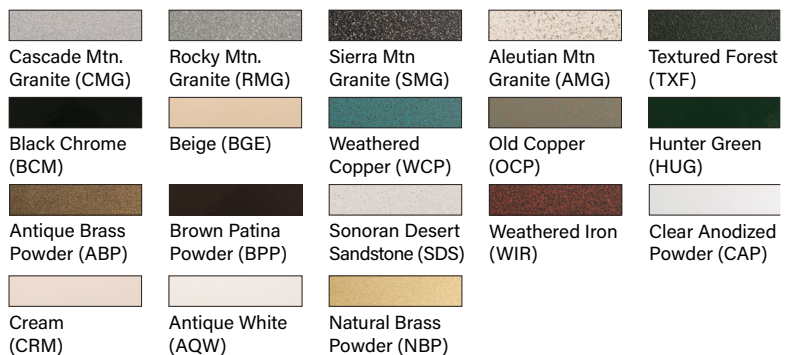



[Click Here](#) to view larger, full-color swatches of all available finishes on our website.

DATE:	PROJECT:	TYPE:
-------	----------	-------

ACCESSORIES (Configure separately)

SPECIFICATIONS

Electrical	INSPIRATION (BLUETOOTH WIRELESS TECHNOLOGY)	Wireless communication system creates dynamic lumen response at the individual fixture. Indexed (100% to 5% nom.) lumen output. Maintains output at desired level or may be changed as conditions require via exclusive mobile application. App available at the Apple App® Store. CCT modulation between 1650K through 4000K. Full saturation and hue control enables selection of any single color point off the Planckian curve for dynamic full color output. A copy/paste function permits replication of the current selection to other modules within the wireless network. Wireless control up to 5 feet.
	BLUETOOTH CONNECTIVITY REQUIREMENTS	iOS device (by others) with Inspiration Control System app is required for wireless Bluetooth® control. Works with iPhone® (4S or newer); iPad® (3rd generation or newer); iPad mini®; iPad Air®; iPod® Touch (5th generation or newer).
	0-10V WIRED CONTROL	Requires two (2) sets of 0-10V industry wired controls wired direct to the fixture. One provides CCT modulation between 1650K through 8000K in 1% increments. The second enables 5-100% dimming in 1% increments. iOS device may also be utilized to select a single color point off the Planckian curve for dynamic full color output with the remaining functions enabled by the 0-10V controls.
	DRIVER	Two (2) 1.75A, Class A (sound), Class II (isolation) drivers. 120VAC (nominal) primary input voltage. 50/60Hz. >0.90 Power Factor, 20% THD (nominal at 120VAC full load). Output over-voltage, over-current, and short circuit protection.
PHYSICAL	SURFACE MOUNT	For use with side entry, surface conduits. Stainless steel mounting brackets provide for direct anchor to architectural surfaces in any orientation.
	HOUSING	Copper free, aluminum extrusion with die cast end caps. Surface mounted with flow through back channel to prevent water and debris collection. Machined aluminum cover with countersunk holes for flush hardware installation. Tamper-resistant, captive, black oxide stainless steel mounting screws. Front access for ease of installation and inspection. Two (2) 3/4" NPT female conduit entries per end cap for through wiring.
	INSTALLATION TETHER	Stainless steel cable with integral loop allows cover to temporarily suspend from housing during installation to simplify wire connection and component attachment.
	PATENTED KNOCKOUTS	Four (4) 3/4" NPT, machined aluminum knockouts. High temperature, silicone 'O' Ring for water-tight seal. Patented design allows knockout to be reinserted without compromising seal integrity.
	FINISH	StarGuard, our 15-stage, chromate-free process cleans and conversion coats aluminum components prior to application of Class 'A' TGIC polyester powder coating and is RoHS compliant. Finish to match fixture. (specified separately).
	WARRANTY	5-year limited warranty.
	CERTIFICATION & LISTING	Certified to CAN/CSA/ANSI Standards. UL Listed. NEMA 4X / IP66 Rated Enclosure. RoHS compliant. Made in USA with sustainable processes.
  		

B-K LIGHTING

MADE IN THE USA

559.438.5800 | INFO@BKLIGHTING.COM | BKLIGHTING.COM

DATE:	PROJECT:	TYPE:
-------	----------	-------

CATALOG NUMBER LOGIC:

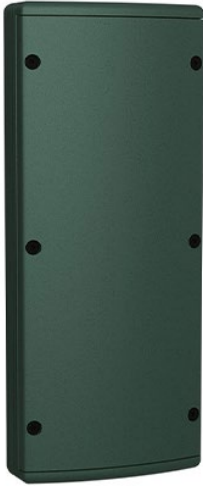
**CATALOG NUMBER LOGIC**

Example: PM3DRM - CR - 010 - BLP - MT - MB

MATERIAL

Aluminum

SERIES

PM3DRM - Universal Power Module 3 Dual Remote

MOUNTING

CR - Round Camlock Canopy (Recessed Junction Box)

CONTROL

010 - 0-10V Wired Installation*

BT - Bluetooth (See requirements)**

FINISH (See page 2 for full-color swatches)

Standard Finishes (BZP, BZW, BLP, BLW, WHP, WHW, SAP, VER)

Premium Finish (ABP, AMG, AQW, BCM, BGE, BPP, CAP, CMG, CRM, HUG, NBP, OCP, RMG, SDS, SMG, TXF, WCP, WIR)

(Also available in RAL Finishes. See submittal SUB-1439-00)

INPUT VOLTAGE

MT - 120-277 VAC

OPTIONS

MB - Mounting Brackets

Requires 2 sets of 0-10V controls. Sold separately.**Bluetooth control system requirements. For use with iPod Touch 5 or later, Mini iPad, iPad3 (2012) or later or iPhone 4S or later.*

DATE: _____ PROJECT: _____ TYPE: _____

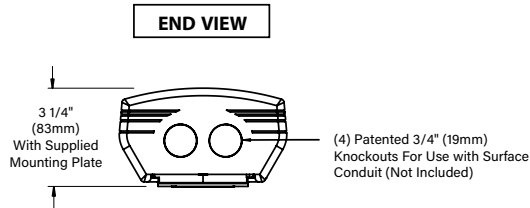
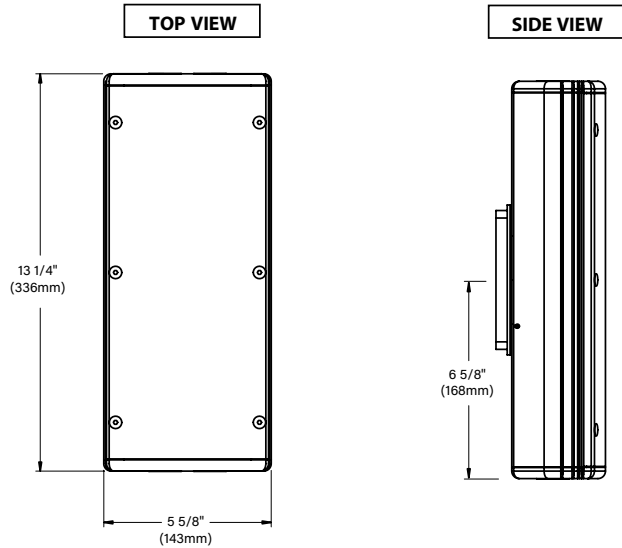

⚠ REMOTE WIRING

LED Driver

Remote driver installations require inter-connected wiring between the LED and driver (by others). Drivers have specific wiring requirements between these components. Driver manufacturers regularly recommend the following wiring details for such installations:

- Do not exceed 50 foot overall wiring distance using 12 gauge copper wire.

Failure to comply with specific wiring requirements will void product warranty.

ROUND CAMLOCK™ CANOPY

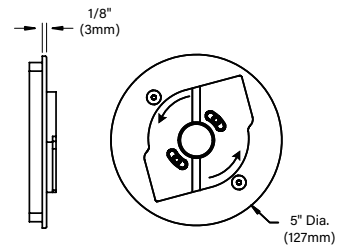

0-10V WIRED CONTROL

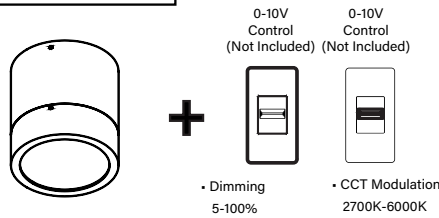

IOS DEVICE CONTROL

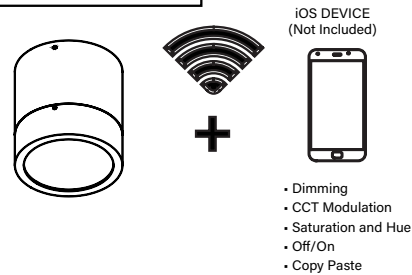

STANDARD FINISHES



PREMIUM FINISHES

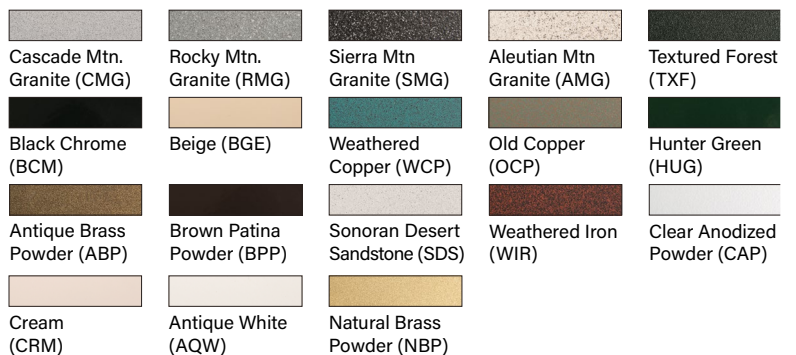



[Click Here](#) to view larger, full-color swatches of all available finishes on our website.

DATE:	PROJECT:	TYPE:
-------	----------	-------

ACCESSORIES (Configure separately)

SPECIFICATIONS

Electrical	INSPIRATION (BLUETOOTH WIRELESS TECHNOLOGY)	Wireless communication system creates dynamic lumen response at the individual fixture. Indexed (100% to 5% nom.) lumen output. Maintains output at desired level or may be changed as conditions require via exclusive mobile application. App available at the Apple App® Store. CCT modulation between 1650K through 4000K. Full saturation and hue control enables selection of any single color point off the Planckian curve for dynamic full color output. A copy/paste function permits replication of the current selection to other modules within the wireless network. Wireless control up to 5 feet.
	BLUETOOTH CONNECTIVITY REQUIREMENTS	iOS device (by others) with Inspiration Control System app is required for wireless Bluetooth® control. Works with iPhone® (4S or newer); iPad® (3rd generation or newer); iPad mini®; iPad Air®; iPod® Touch (5th generation or newer).
	0-10V WIRED CONTROL	Requires two (2) sets of 0-10V industry wired controls wired direct to the fixture. One provides CCT modulation between 1650K through 8000K in 1% increments. The second enables 5-100% dimming in 1% increments. iOS device may also be utilized to select a single color point off the Planckian curve for dynamic full color output with the remaining functions enabled by the 0-10V controls.
	DRIVER	Two (2) 1.75A, Class A (sound), Class II (isolation) drivers. 120VAC (nominal) primary input voltage. 50/60Hz. >0.90 Power Factor, 20% THD (nominal at 120VAC full load). Output over-voltage, over-current, and short circuit protection.
PHYSICAL	ROUND CAMLOCK CANOPY (RECESSED JUNCTION BOX)	5" dia., machined aluminum construction. Includes stainless steel universal mounting ring for use with 4" octagonal junction box. Two (2) tamper-resistant, black oxide stainless steel mounting screws. 1/8" thick HT-805A silicone foam gasket for water-tight seal. Integral Camlock provides additional 30° adjustment for precision alignment of UPM regardless of junction box orientation. Integral wiper seal maintains water-tight integrity between UPM and junction box. Optional stainless steel mounting brackets may be specified to provide additional anchor to architectural surface.
	HOUSING	Copper free, aluminum extrusion with die cast end caps. Surface mounted with flow through back channel to prevent water and debris collection. Machined aluminum cover with countersunk holes for flush hardware installation. Tamper-resistant, captive, black oxide stainless steel mounting screws. Front access for ease of installation and inspection. Two (2) 3/4" NPT female conduit entries per end cap for through wiring.
	INSTALLATION TETHER	Stainless steel cable with integral loop allows cover to temporarily suspend from housing during installation to simplify wire connection and component attachment.
	PATENTED KNOCKOUTS	Four (4) 3/4" NPT, machined aluminum knockouts. High temperature, silicone 'O' Ring for water-tight seal. Patented design allows knockout to be reinserted without compromising seal integrity.
	FINISH	StarGuard, our 15-stage, chromate-free process cleans and conversion coats aluminum components prior to application of Class 'A' TGIC polyester powder coating and is RoHS compliant. Finish to match fixture. (specified separately).
	WARRANTY	5-year limited warranty.
	CERTIFICATION & LISTING	Certified to CAN/CSA/ANSI Standards. UL Listed. NEMA 4X / IP66 Rated Enclosure. RoHs compliant. Made in USA with sustainable processes.
  		

B-K LIGHTING
MADE IN THE USA

 559.438.5800 | INFO@BKLIGHTING.COM | BKLIGHTING.COM