

DATE:	PROJECT:	TYPE:
-------	----------	-------

CATALOG NUMBER LOGIC:



*Lamp details available on the 3rd page.

CATALOG NUMBER LOGIC

Example: B - CD - VBL - MR - 359 - BLW - D

MATERIAL

(Blank) - Aluminum B - Brass S - Stainless Steel

INSTALLATION

CD - Core Drill

SERIES

VBL - Louvered Vertical Brick Star

SOURCE

MR - MR16 Lamp

LAMP TYPE

0 - MR16 HALOGEN LAMP (Furnished by others)

MR16 LED (This choice requires lamp number selection)*

FINISH (See page 2 for full-color swatches)

Standard Finishes (BZP, BZW, BLP, BLW, WHP, WHW, SAP, VER)

Premium Finish (ABP, AMG, AQW, BCM, BGE, BPP, CAP, CMG, CRM, HUG, NBP, OCP, RMG, SDS, SMG, TXF, WCP, WIR)

Also available in RAL Finishes

Brass Finishes (MAC, POL, MIT)

Stainless Steel Finishes (MAC, POL)

LOUVER

D - 30° Angle, Rectangular Pattern

DATE: _____ PROJECT: _____ TYPE: _____

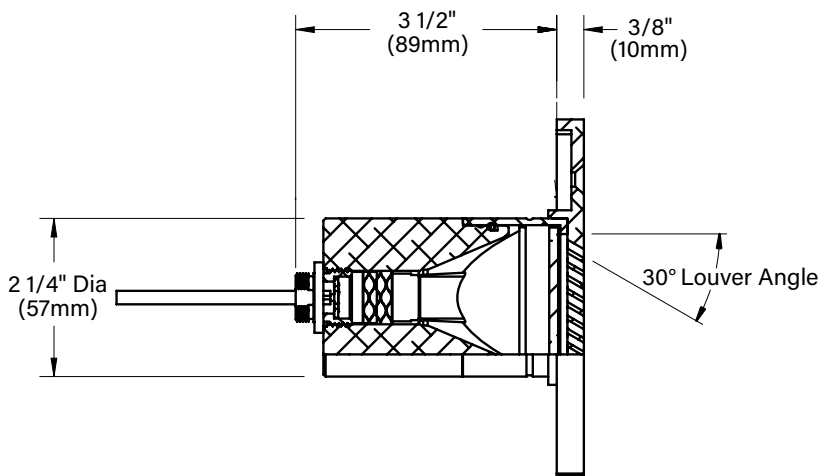
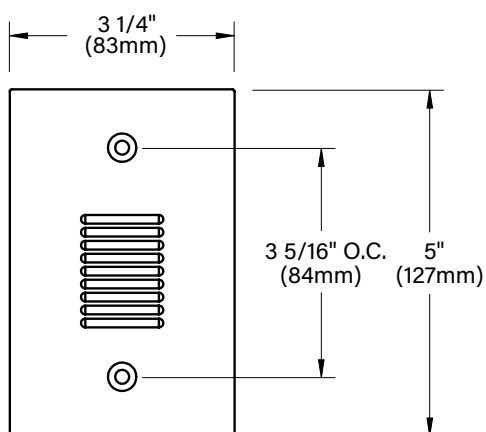

STANDARD FINISHES



PREMIUM FINISHES







[Click Here](#) to view larger, full-color swatches of all available finishes on our website.

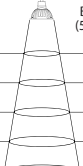

By SORAA™

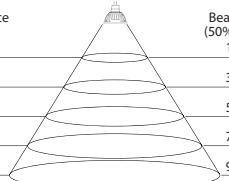
MR16 LED LAMP

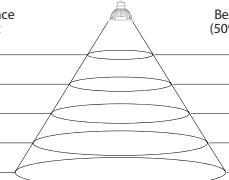
<p>B-K Lamp # 359 Base: GU5.3 Bi-Pin Input Voltage: 12V CCT: 2700K Beam: 10° Spot</p>	<p>Mfg. #: MR16- SM16-07-10D-827-H1 Wattage: 7.5W Lamp Efficacy: 77 (Lm/W) Rated Life: 35,000 hrs</p>	<p>CBCP (cd): 8000 CRI: >90 Power Factor: 0.92 Dimmable: Yes Lumens: 575</p>	 <table border="1"> <thead> <tr> <th>Distance feet</th> <th>Beam Dia. (50% CBCP)</th> <th>Footcandles</th> </tr> </thead> <tbody> <tr><td>3'</td><td>0.5'</td><td>634</td></tr> <tr><td>6'</td><td>1.0'</td><td>160</td></tr> <tr><td>9'</td><td>1.6'</td><td>69</td></tr> <tr><td>12'</td><td>2.1'</td><td>40</td></tr> <tr><td>15'</td><td>2.6'</td><td>23</td></tr> </tbody> </table>	Distance feet	Beam Dia. (50% CBCP)	Footcandles	3'	0.5'	634	6'	1.0'	160	9'	1.6'	69	12'	2.1'	40	15'	2.6'	23
Distance feet	Beam Dia. (50% CBCP)	Footcandles																			
3'	0.5'	634																			
6'	1.0'	160																			
9'	1.6'	69																			
12'	2.1'	40																			
15'	2.6'	23																			
<p>B-K Lamp # 361 Base: GU5.3 Bi-Pin Input Voltage: 12V CCT: 2700K Beam: 25° Narrow Flood</p>	<p>Mfg. #: MR16- SM16-07-25D-827-H1 Wattage: 7.5W Lamp Efficacy: 80 (Lm/W) Rated Life: 35,000 hrs</p>	<p>CBCP (cd): 3170 CRI: >90 Power Factor: 0.92 Dimmable: Yes Lumens: 600</p>	 <table border="1"> <thead> <tr> <th>Distance feet</th> <th>Beam Dia. (50% CBCP)</th> <th>Footcandles</th> </tr> </thead> <tbody> <tr><td>3'</td><td>1.3'</td><td>251</td></tr> <tr><td>6'</td><td>2.7'</td><td>63</td></tr> <tr><td>9'</td><td>4.0'</td><td>27</td></tr> <tr><td>12'</td><td>5.3'</td><td>16</td></tr> <tr><td>15'</td><td>6.7'</td><td>9</td></tr> </tbody> </table>	Distance feet	Beam Dia. (50% CBCP)	Footcandles	3'	1.3'	251	6'	2.7'	63	9'	4.0'	27	12'	5.3'	16	15'	6.7'	9
Distance feet	Beam Dia. (50% CBCP)	Footcandles																			
3'	1.3'	251																			
6'	2.7'	63																			
9'	4.0'	27																			
12'	5.3'	16																			
15'	6.7'	9																			
<p>B-K Lamp # 362 Base: GU5.3 Bi-Pin Input Voltage: 12V CCT: 2700K Beam: 36° Flood</p>	<p>Mfg. #: MR16- SM16-07-36D-827-H1 Wattage: 7.5W Lamp Efficacy: 80 (Lm/W) Rated Life: 35,000 hrs</p>	<p>CBCP (cd): 1550 CRI: >90 Power Factor: 0.92 Dimmable: Yes Lumens: 600</p>	 <table border="1"> <thead> <tr> <th>Distance feet</th> <th>Beam Dia. (50% CBCP)</th> <th>Footcandles</th> </tr> </thead> <tbody> <tr><td>3'</td><td>1.9'</td><td>119</td></tr> <tr><td>6'</td><td>3.9'</td><td>30</td></tr> <tr><td>9'</td><td>5.8'</td><td>13</td></tr> <tr><td>12'</td><td>7.8'</td><td>7</td></tr> <tr><td>15'</td><td>9.7'</td><td>4</td></tr> </tbody> </table>	Distance feet	Beam Dia. (50% CBCP)	Footcandles	3'	1.9'	119	6'	3.9'	30	9'	5.8'	13	12'	7.8'	7	15'	9.7'	4
Distance feet	Beam Dia. (50% CBCP)	Footcandles																			
3'	1.9'	119																			
6'	3.9'	30																			
9'	5.8'	13																			
12'	7.8'	7																			
15'	9.7'	4																			
<p>B-K Lamp # 363 Base: GU5.3 Bi-Pin Input Voltage: 12V CCT: 3000K Beam: 10° Spot</p>	<p>Mfg. #: MR16- SM16-07-10D-830-H1 Wattage: 7.5W Lamp Efficacy: 80 (Lm/W) Rated Life: 35,000 hrs</p>	<p>CBCP (cd): 8400 CRI: >90 Power Factor: 0.92 Dimmable: Yes Lumens: 600</p>	 <table border="1"> <thead> <tr> <th>Distance feet</th> <th>Beam Dia. (50% CBCP)</th> <th>Footcandles</th> </tr> </thead> <tbody> <tr><td>3'</td><td>0.5'</td><td>666</td></tr> <tr><td>6'</td><td>1.0'</td><td>168</td></tr> <tr><td>9'</td><td>1.6'</td><td>72</td></tr> <tr><td>12'</td><td>2.1'</td><td>42</td></tr> <tr><td>15'</td><td>2.6'</td><td>24</td></tr> </tbody> </table>	Distance feet	Beam Dia. (50% CBCP)	Footcandles	3'	0.5'	666	6'	1.0'	168	9'	1.6'	72	12'	2.1'	42	15'	2.6'	24
Distance feet	Beam Dia. (50% CBCP)	Footcandles																			
3'	0.5'	666																			
6'	1.0'	168																			
9'	1.6'	72																			
12'	2.1'	42																			
15'	2.6'	24																			
<p>B-K Lamp # 365 Base: GU5.3 Bi-Pin Input Voltage: 12V CCT: 3000K Beam: 25° Narrow Flood</p>	<p>Mfg. #: MR16- SM16-07-25D-830-H1 Wattage: 7.5W Lamp Efficacy: 84 (Lm/W) Rated Life: 35,000 hrs</p>	<p>CBCP (cd): 3300 CRI: >90 Power Factor: 0.92 Dimmable: Yes Lumens: 630</p>	 <table border="1"> <thead> <tr> <th>Distance feet</th> <th>Beam Dia. (50% CBCP)</th> <th>Footcandles</th> </tr> </thead> <tbody> <tr><td>3'</td><td>1.3'</td><td>266</td></tr> <tr><td>6'</td><td>2.7'</td><td>67</td></tr> <tr><td>9'</td><td>4.0'</td><td>29</td></tr> <tr><td>12'</td><td>5.3'</td><td>17</td></tr> <tr><td>15'</td><td>6.7'</td><td>10</td></tr> </tbody> </table>	Distance feet	Beam Dia. (50% CBCP)	Footcandles	3'	1.3'	266	6'	2.7'	67	9'	4.0'	29	12'	5.3'	17	15'	6.7'	10
Distance feet	Beam Dia. (50% CBCP)	Footcandles																			
3'	1.3'	266																			
6'	2.7'	67																			
9'	4.0'	29																			
12'	5.3'	17																			
15'	6.7'	10																			
<p>B-K Lamp # 366 Base: GU5.3 Bi-Pin Input Voltage: 12V CCT: 3000K Beam: 36° Flood</p>	<p>Mfg. #: MR16- SM16-07-36D-830-H1 Wattage: 7.5W Lamp Efficacy: 84 (Lm/W) Rated Life: 35,000 hrs</p>	<p>CBCP (cd): 1650 CRI: >90 Power Factor: 0.92 Dimmable: Yes Lumens: 630</p>	 <table border="1"> <thead> <tr> <th>Distance feet</th> <th>Beam Dia. (50% CBCP)</th> <th>Footcandles</th> </tr> </thead> <tbody> <tr><td>3'</td><td>1.9'</td><td>125</td></tr> <tr><td>6'</td><td>3.9'</td><td>32</td></tr> <tr><td>9'</td><td>5.8'</td><td>14</td></tr> <tr><td>12'</td><td>7.8'</td><td>8</td></tr> <tr><td>15'</td><td>9.7'</td><td>5</td></tr> </tbody> </table>	Distance feet	Beam Dia. (50% CBCP)	Footcandles	3'	1.9'	125	6'	3.9'	32	9'	5.8'	14	12'	7.8'	8	15'	9.7'	5
Distance feet	Beam Dia. (50% CBCP)	Footcandles																			
3'	1.9'	125																			
6'	3.9'	32																			
9'	5.8'	14																			
12'	7.8'	8																			
15'	9.7'	5																			

B-K LIGHTING

MADE IN THE USA

559.438.5800 | INFO@BKLIGHTING.COM | BKLIGHTING.COM

THIS DOCUMENT CONTAINS PROPRIETARY INFORMATION OF B-K LIGHTING, INC. AND ITS RECEIPT OR POSSESSION DOES NOT CONVEY ANY RIGHTS TO REPRODUCE, DISCLOSE ITS CONTENTS, OR TO MANUFACTURE, USE OR SELL ANYTHING IT MAY DESCRIBE. REPRODUCTION, DISCLOSURE OR USE WITHOUT SPECIFIC WRITTEN AUTHORIZATION OF B-K LIGHTING, INC. IS STRICTLY FORBIDDEN.

LOUVERED VERTICAL BRICK STAR (MR16 LAMP - CORE DRILL)

IP65 RATED

DATE:	PROJECT:	TYPE:
-------	----------	-------

ACCESSORIES (Configure separately)

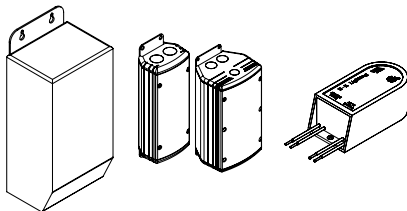

TR Series

UPMRM

TRSS-75

SPECIFICATIONS

ELECTRICAL	WATTAGE	7.5W
	SOCKET	Specification grade, ceramic body, miniature bi-pin quartz lamp holder. GU5.3 base. Nickel alloy contacts and heat resistant, spring loaded, stainless steel lamp retaining dips.
	WIRING	Teflon-coated, 18AWG, 600V, 250° C rated and certified to UL 1659 standard. Anti-Siphon Valve (ASV) prevents 'wicking' through conductor insulation.
	TRANSFORMER	For use with 12VAC remote transformer.
PHYSICAL	MATERIALS	Furnished in copper-free aluminum (6061-T6), brass (360) or stainless steel (304).
	CORE DRILL	Allows for mounting into existing structures that will not easily accept a standard box. Machined from solid, copper-free aluminum. Weather-tight cable connector with 5'0", 12Ga., 2 wire low voltage cable. 2-1/2" dia. hole required for slip fit.
	FACEPLATE	Machined from solid, copper-free aluminum. Also available in solid, machined brass and stainless steel. Countersunk holes provide for flush hardware mounting.
	LAMP	For use with bi-pin MR16 lamps. Not for use with IR technology lamps. Halogen sourced by others.
	INSTALLATION	For use with 50W maximum lamp when installed into non-combustible materials.
	LENS	Heat treated rectilinear lens provides wide lateral distribution and long forward throw.
	LOUVERS & AIMING	Louver pattern is machined into faceplate to prevent direct view to the lamp at 0°, 30° optical cutoff for mounting heights well below typical visual glare angles.
	FINISH	StarGuard, our 15-stage chromate-free process cleans and conversion coats aluminum components prior to application of Class 'A' TGIC polyester powder coating and is RoHS compliant. Powder coat or metal finish options available for brass material and metal finish option only for stainless steel material.
WARRANTY	5-year limited warranty.	
CERTIFICATION & LISTING	ITL tested to IESNA LM-79. UL Listed. Certified to CAN/CSA/ANSI Standards. RoHS compliant. Suitable for indoor or outdoor use, in wet locations, and for installation in combustible materials (Type Non-IC) and within 4' of the ground. IP65 Rated. Made in the USA with sustainable processes.	



B-K LIGHTING

MADE IN THE USA

559.438.5800 | INFO@BKLIGHTING.COM | BKLIGHTING.COM