

# DENALI - PM2RM DRIVER HOUSING (BLUETOOTH - TREE STRAP) ORDER FIXTURE SEPARATELY.

DATE:	PROJECT:	TYPE:
-------	----------	-------

CATALOG NUMBER LOGIC:



*\*Requires 2 sets of 0-10V controls. Sold separately.*

*\*\*Bluetooth control system requirements. For use with iPod Touch 5 or later, Mini iPad, iPad3 (2012) or later or iPhone 4S or later.*

## CATALOG NUMBER LOGIC

Example: PM2RM - TS-20 - BT - BZP - MT - MB

## MATERIAL

Aluminum

## SERIES

PM2RM - Universal Power Module 2 Remote

## MOUNTING

TS-Length - Tree Strap (Specify adjustable strap length) 18" Standard Min.

## CONTROL

010 - 0-10V Wired Installation\*

BT - Bluetooth (See requirements)\*\*

## FINISH

Standard Finishes (BZP, BZW, BLP, BLW, WHP, WHW, SAP, VER)

Premium Finish (ABP, AMG, AQW, BCM, BGE, BPP, CAP, CMG, CRI, CRM, HUG, MDS, NBP, OCP, RMG, SDS, SMG, TXF, WCP, WIR)

(Also available in RAL Finishes. See submittal SUB-1439-00)

## INPUT VOLTAGE

MT - 120-277 VAC (For use with 20W LED color tuning fixtures)

## OPTIONS

SC - Safety Cable for use with Tree Strap Mount. Cable length to match strap length. 18" Standard Min.

MB - Mounting Brackets

**B-K LIGHTING**

**MADE IN THE USA**

559.438.5800 | [INFO@BKLIGHTING.COM](mailto:INFO@BKLIGHTING.COM) | [BKLIGHTING.COM](http://BKLIGHTING.COM)

**DENALI - PM2RM DRIVER HOUSING (BLUETOOTH - TREE STRAP) ORDER FIXTURE SEPARATELY.**

DATE: \_\_\_\_\_ PROJECT: \_\_\_\_\_ TYPE: \_\_\_\_\_

**FRONT VIEW**

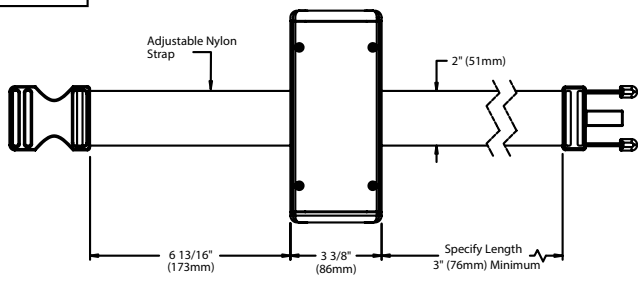

**END VIEW**

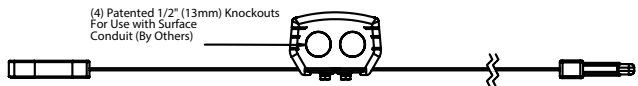

**SAFETY CABLE**

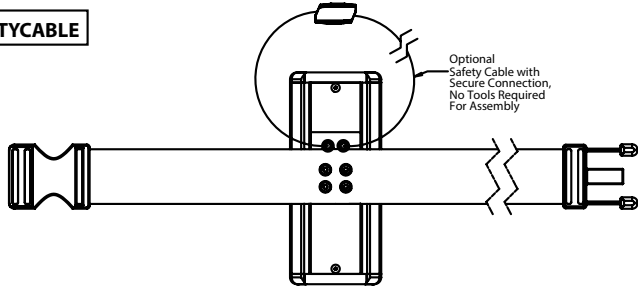

**! REMOTEWIRING**

**LED Driver**  
 Remote driver installations require inter-connected wiring between the LED and driver (by others). Drivers have specific wiring requirements between these components. Driver manufacturers regularly recommend the following wiring details for such installations:

- Do not exceed 50 foot overall wiring distance using 12 gauge copper wire.

**Failure to comply with specific wiring requirements will void product warranty.**

**OPTIONAL MOUNTING BRACKET**

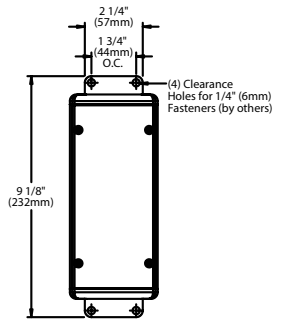

**0-10V WIRED CONTROL**

For use with: **C22 - 20WLED/1650-8000K + Dimming and CCT only**  
 (0-10V Wired Installation)

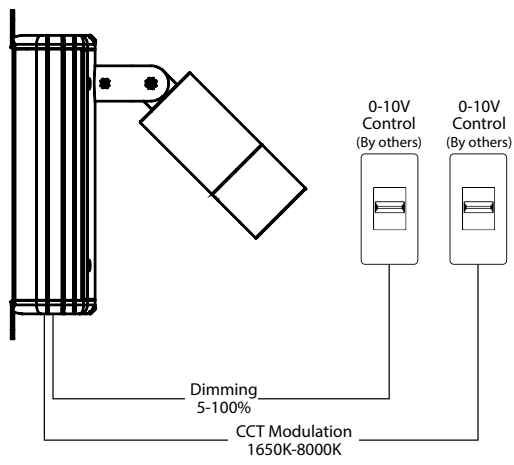

**IOS DEVICE CONTROL**

For use with: **C22 - 20WLED/1650-8000K + Saturation and Hue**  
 (Bluetooth Installation)

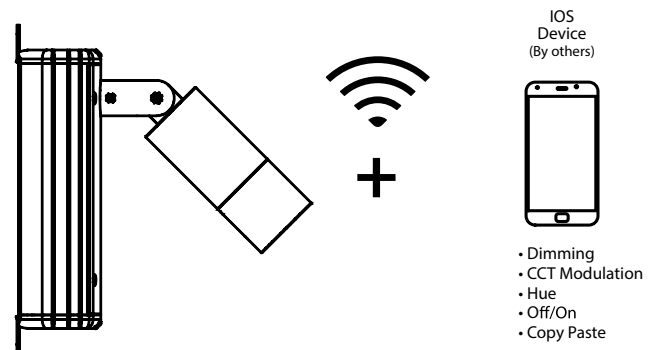



THIS DOCUMENT CONTAINS PROPRIETARY INFORMATION OF B-K LIGHTING, INC. AND ITS RECEIPT OR POSSESSION DOES NOT CONVEY ANY RIGHTS TO REPRODUCE, DISCLOSE ITS CONTENTS, OR TO MANUFACTURE, USE OR SELL ANYTHING IT MAY DESCRIBE. REPRODUCTION, DISCLOSURE OR USE WITHOUT SPECIFIC WRITTEN AUTHORIZATION OF B-K LIGHTING, INC. IS STRICTLY FORBIDDEN. 05/28/2020 SKU-1231 PM2RM P1

# DENALI - PM2RM DRIVER HOUSING (BLUETOOTH - TREE STRAP) ORDER FIXTURE SEPARATELY.

DATE:	PROJECT:	TYPE:
-------	----------	-------

ACCESSORIES (Configure separately)

## SPECIFICATIONS

Electrical	INSPIRATION (BLUETOOTH WIRELESS TECHNOLOGY)	Wireless communication system creates dynamic lumen response at the individual fixture. Indexed (100% to 5% nom.) lumen output. Maintains output at desired level or may be changed as conditions require via exclusive mobile application. App available at the Apple App® Store. CCT modulation between 1650K through 4000K. Full saturation and hue control enables selection of any single color point off the Planckian curve for dynamic full color output. A copy/paste function permits replication of the current selection to other modules within the wireless network. Wireless control up to 5 feet.
	BLUETOOTH CONNECTIVITY REQUIREMENTS	iOS device (by others) with Inspiration Control System app is required for wireless Bluetooth® control. Works with iPhone® (4S or newer); iPad® (3rd generation or newer); iPad mini®; iPad Air®; iPod® Touch (5th generation or newer).
	0-10V WIRED CONTROL	Requires two (2) sets of 0-10V industry wired controls wired direct to the fixture. One provides CCT modulation between 1650K through 8000K in 1% increments. The second enables 5-100% dimming in 1% increments. iOS device may also be utilized to select a single color point off the Planckian curve for dynamic full color output with the remaining functions enabled by the 0-10V controls.
	DRIVER	One (1) 1.75A, Class A (sound), Class II (isolation) driver. 120VAC (nominal) primary input voltage. 50/60Hz. >0.90 Power Factor, 20% THD (nominal at 120VAC full load). Output over-voltage, over-current, and short circuit protection.
PHYSICAL	TREE INSTALLATION	Tree Strap mounting system facilitates non-invasive installation. Adjustable nylon strap is mold and mildew resistant and will not hinder tree growth. Stainless steel safety cable maintains UPM mounting when nylon strap is disengaged.
	HOUSING	Copper free, aluminum extrusion with die cast end caps. Surface mounted with flow through back channel to prevent water and debris collection. Machined aluminum cover with countersunk holes for flush hardware installation. Tamper-resistant, captive, black oxide stainless steel mounting screws. Front access for ease of installation and inspection. Two (2) 1/2" NPT female conduit entries per end cap for through wiring.
	INSTALLATION TETHER	Stainless steel cable with integral loop allows cover to temporarily suspend from housing during installation to simplify wire connection and component attachment.
	PATENTED KNOCKOUTS	Four (4) 1/2" NPT, machined aluminum knockouts. High temperature, silicone 'O' Ring for water-tight seal. Patented design allows knockout to be reinserted without compromising seal integrity.
	FINISH	StarGuard, our 15-stage, chromate-free process cleans and conversion coats aluminum components prior to application of Class 'A' TGIC polyester powder coating and is RoHS compliant. Finish to match fixture. (specified separately).
	WARRANTY CERTIFICATION & LISTING	5-year limited warranty. Certified to CAN/CSA/ANSI Standards. UL Listed. NEMA 4X / IP66 Rated Enclosure. RoHs compliant. Made in USA with sustainable processes.
  		

**B-K LIGHTING**

**MADE IN THE USA**

559.438.5800 | INFO@BKLIGHTING.COM | BKLIGHTING.COM

# DENALI - PM2RM DRIVER HOUSING (BLUETOOTH - SURFACE MOUNT) ORDER FIXTURE SEPARATELY.

DATE:	PROJECT:	TYPE:
-------	----------	-------

CATALOG NUMBER LOGIC:



*\*Requires 2 sets of 0-10V controls. Sold separately.*

*\*\*Bluetooth control system requirements. For use with iPod Touch 5 or later, Mini iPad, iPad3 (2012) or later or iPhone 4S or later.*

## CATALOG NUMBER LOGIC

Example: PM2RM - SM - BT - BZP - MT

## MATERIAL

Aluminum

## SERIES

PM2RM - Universal Power Module 2 Remote

## MOUNTING

SM - Surface Mount

## CONTROL

010 - 0-10V Wired Installation\*

BT - Bluetooth (See requirements)\*\*

## FINISH

Standard Finishes (BZP, BZW, BLP, BLW, WHP, WHW, SAP, VER)

Premium Finish (ABP, AMG, AQW, BCM, BGE, BPP, CAP, CMG, CRI, CRM, HUG, MDS, NBP, OCP, RMG, SDS, SMG, TXF, WCP, WIR)

(Also available in RAL Finishes. See submittal SUB-1439-00)

## INPUT VOLTAGE

MT - 120-277 VAC (For use with 20W LED Color tuning fixtures)

**B-K LIGHTING**

**MADE IN THE USA**

559.438.5800 | [INFO@BKLIGHTING.COM](mailto:INFO@BKLIGHTING.COM) | [BKLIGHTING.COM](http://BKLIGHTING.COM)

DATE: \_\_\_\_\_ PROJECT: \_\_\_\_\_ TYPE: \_\_\_\_\_

**! REMOTEWIRING**

**END VIEW**

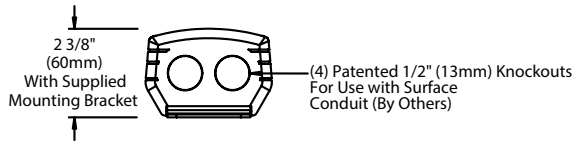

**TOP VIEW**

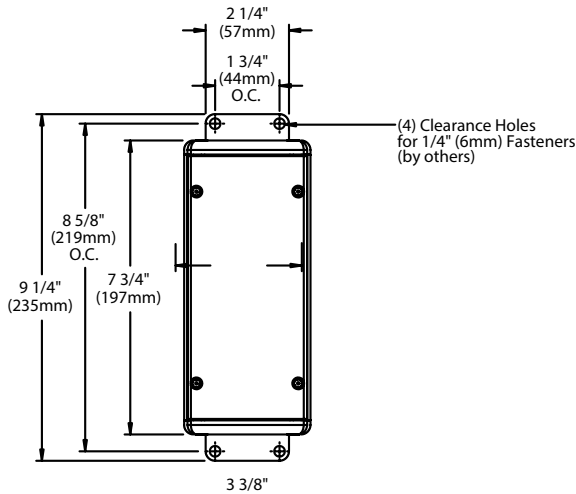

**SIDEVIEW**

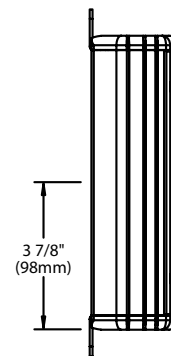

**LED Driver**  
Remote driver installations require inter-connected wiring between the LED and driver (by others). Drivers have specific wiring requirements between these components. Driver manufacturers regularly recommend the following wiring details for such installations:

- Do not exceed 50 foot overall wiring distance using 12 gauge copper wire.

**Failure to comply with specific wiring requirements will void product warranty.**

**0-10V WIRED CONTROL**

For use with: **C22** - 20WLED/1650-8000K + Dimming and CCT only  
(0-10V Wired Installation)

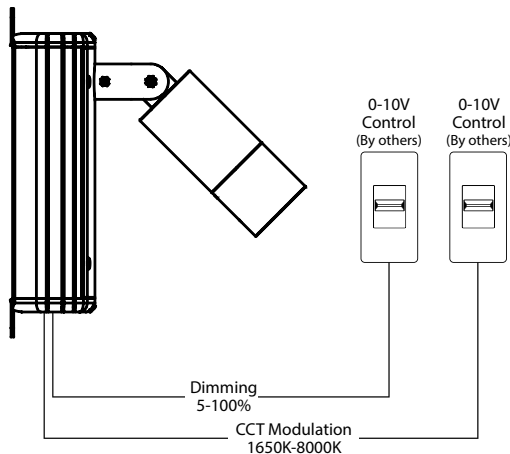

**IOS DEVICE CONTROL**

For use with: **C22** - 20WLED/1650-8000K + Saturation and Hue  
(Bluetooth Installation)

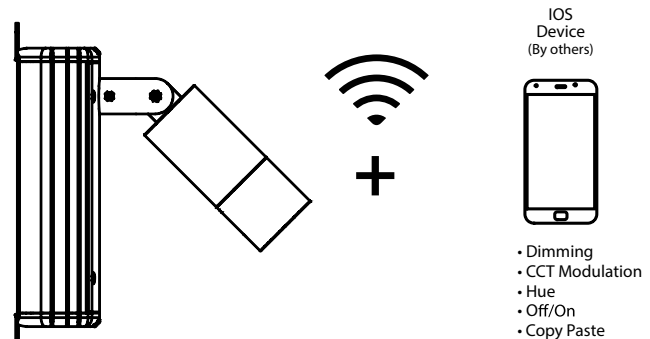

# DENALI - PM2RM DRIVER HOUSING (BLUETOOTH - SURFACE MOUNT) ORDER FIXTURE SEPARATELY.

DATE:	PROJECT:	TYPE:
-------	----------	-------

ACCESSORIES (Configure separately)

## SPECIFICATIONS

Electrical	INSPIRATION (BLUETOOTH WIRELESS TECHNOLOGY)	Wireless communication system creates dynamic lumen response at the individual fixture. Indexed (100% to 5% nom.) lumen output. Maintains output at desired level or may be changed as conditions require via exclusive mobile application. App available at the Apple App® Store. CCT modulation between 1650K through 4000K. Full saturation and hue control enables selection of any single color point off the Planckian curve for dynamic full color output. A copy/paste function permits replication of the current selection to other modules within the wireless network. Wireless control up to 5 feet.
	BLUETOOTH CONNECTIVITY REQUIREMENTS	iOS device (by others) with Inspiration Control System app is required for wireless Bluetooth® control. Works with iPhone® (4S or newer); iPad® (3rd generation or newer); iPad mini®; iPad Air®; iPod® Touch (5th generation or newer).
	0-10V WIRED CONTROL	Requires two (2) sets of 0-10V industry wired controls wired direct to the fixture. One provides CCT modulation between 1650K through 8000K in 1% increments. The second enables 5-100% dimming in 1% increments. iOS device may also be utilized to select a single color point off the Planckian curve for dynamic full color output with the remaining functions enabled by the 0-10V controls.
	DRIVER	One (1) 1.75A, Class A (sound), Class II (isolation) driver. 120VAC (nominal) primary input voltage. 50/60Hz. >0.90 Power Factor, 20% THD (nominal at 120VAC full load). Output over-voltage, over-current, and short circuit protection.
PHYSICAL	SURFACE MOUNT	For use with side entry, surface conduits. Stainless steel mounting brackets provide for direct anchor to architectural surfaces in any orientation.
	HOUSING	Copper free, aluminum extrusion with die cast end caps. Surface mounted with flow through back channel to prevent water and debris collection. Machined aluminum cover with countersunk holes for flush hardware installation. Tamper-resistant, captive, black oxide stainless steel mounting screws. Front access for ease of installation and inspection. Two (2) 1/2" NPT female conduit entries per end cap for through wiring.
	INSTALLATION TETHER	Stainless steel cable with integral loop allows cover to temporarily suspend from housing during installation to simplify wire connection and component attachment.
	PATENTED KNOCKOUTS	Four (4) 1/2" NPT, machined aluminum knockouts. High temperature, silicone 'O' Ring for water-tight seal. Patented design allows knockout to be reinserted without compromising seal integrity.
	FINISH	StarGuard, our 15-stage, chromate-free process cleans and conversion coats aluminum components prior to application of Class 'A' TGIC polyester powder coating and is RoHS compliant. Finish to match fixture. (specified separately).
	WARRANTY CERTIFICATION & LISTING	5-year limited warranty. Certified to CAN/CSA/ANSI Standards. UL Listed. NEMA 4X / IP66 Rated Enclosure. RoHs compliant. Made in USA with sustainable processes.



**B-K LIGHTING**

**MADE IN THE USA**

559.438.5800 | INFO@BKLIGHTING.COM | BKLIGHTING.COM

# DENALI - PM2RM DRIVER HOUSING (BLUETOOTH - JUNCTION BOX) ORDER FIXTURE SEPARATELY.

DATE:	PROJECT:	TYPE:
-------	----------	-------

CATALOG NUMBER LOGIC:



*\*Requires 2 sets of 0-10V controls. Sold separately.*

*\*\*Bluetooth control system requirements. For use with iPod Touch 5 or later, Mini iPad, iPad3 (2012) or later or iPhone 4S or later.*

## CATALOG NUMBER LOGIC

Example: PM2RM - CR - BT - BZP - MT - MB

## MATERIAL

Aluminum

## SERIES

PM2RM - Universal Power Module 2 Remote

## MOUNTING

CR - Round Camlock Canopy (Recessed Junction Box)

CT - Rectangular Camlock Canopy (Recessed Junction Box)

## CONTROL

010 - 0-10V Wired Installation\*

BT - Bluetooth (See requirements)\*\*

## FINISH

Standard Finishes (BZP, BZW, BLP, BLW, WHP, WHW, SAP, VER)

Premium Finish (ABP, AMG, AQW, BCM, BGE, BPP, CAP, CMG, CRI, CRM, HUG, MDS, NBP, OCP, RMG, SDS, SMG, TXF, WCP, WIR)

(Also available in RAL Finishes. See submittal SUB-1439-00)

## INPUT VOLTAGE

MT - 120-277 VAC (For use with 20W LED color tuning fixtures)

## OPTIONS

MB - Mounting Brackets

**B-K LIGHTING**

**MADE IN THE USA**

559.438.5800 | [INFO@BKLIGHTING.COM](mailto:INFO@BKLIGHTING.COM) | [BKLIGHTING.COM](http://BKLIGHTING.COM)

DATE: \_\_\_\_\_ PROJECT: \_\_\_\_\_ TYPE: \_\_\_\_\_

**OPTIONAL MOUNTING BRACKET**

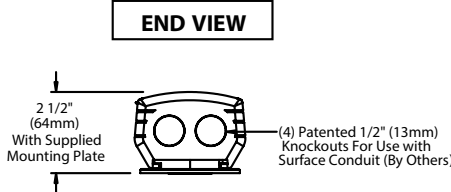
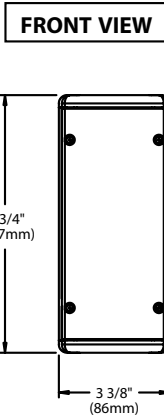
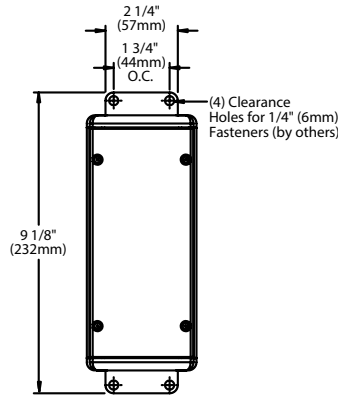
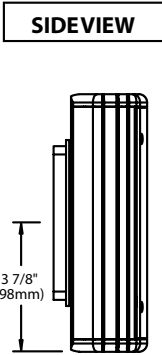

**! REMOTE WIRING**

**LED Driver**

Remote driver installations require inter-connected wiring between the LED and driver (by others). Drivers have specific wiring requirements between these components. Driver manufacturers regularly recommend the following wiring details for such installations:

- Do not exceed 50 foot overall wiring distance using 12 gauge copper wire.

**Failure to comply with specific wiring requirements will void product warranty.**

**RECTANGULAR CAMLOCK™ CANOPY**

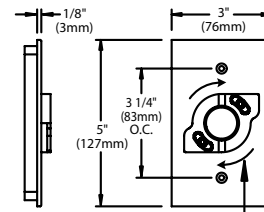

**ROUND CAMLOCK™ CANOPY**

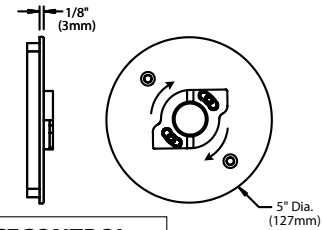

**0-10V WIRED CONTROL**

For use with: **C22 - 20WLED/1650-8000K + Dimming and CCT only**  
(0-10V Wired Installation)

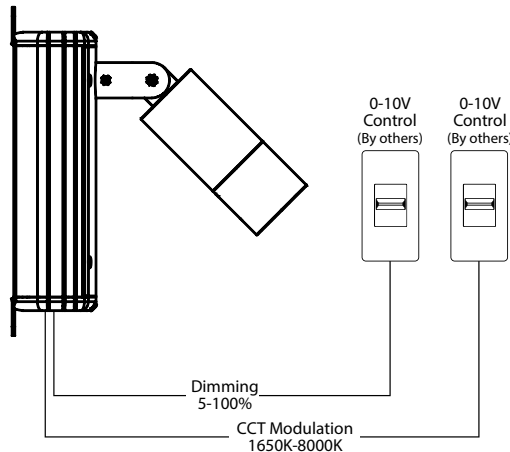

**IOS DEVICE CONTROL**

For use with: **C22 - 20WLED/1650-8000K + Saturation and Hue**  
(Bluetooth Installation)

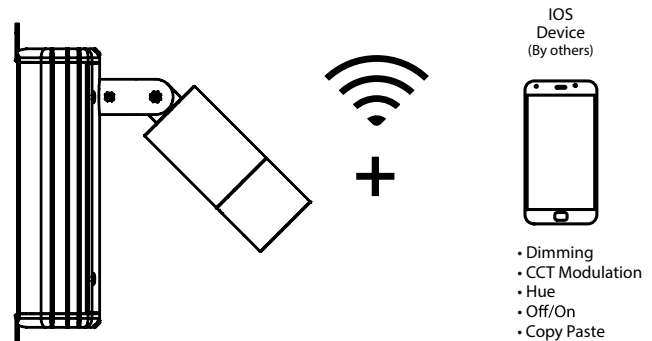





# DENALI - PM2RM DRIVER HOUSING (BLUETOOTH - JUNCTION BOX) ORDER FIXTURE SEPARATELY.

DATE:	PROJECT:	TYPE:
-------	----------	-------

ACCESSORIES (Configure separately)

## SPECIFICATIONS

Electrical	INSPIRATION (BLUETOOTH WIRELESS TECHNOLOGY)	Wireless communication system creates dynamic lumen response at the individual fixture. Indexed (100% to 5% nom.) lumen output. Maintains output at desired level or may be changed as conditions require via exclusive mobile application. App available at the Apple App® Store. CCT modulation between 1650K through 4000K. Full saturation and hue control enables selection of any single color point off the Planckian curve for dynamic full color output. A copy/paste function permits replication of the current selection to other modules within the wireless network. Wireless control up to 5 feet.
	BLUETOOTH CONNECTIVITY REQUIREMENTS	iOS device (by others) with Inspiration Control System app is required for wireless Bluetooth® control. Works with iPhone® (4S or newer); iPad® (3rd generation or newer); iPad mini®; iPad Air®; iPod® Touch (5th generation or newer).
	0-10V WIRED CONTROL	Requires two (2) sets of 0-10V industry wired controls wired direct to the fixture. One provides CCT modulation between 1650K through 8000K in 1% increments. The second enables 5-100% dimming in 1% increments. iOS device may also be utilized to select a single color point off the Planckian curve for dynamic full color output with the remaining functions enabled by the 0-10V controls.
	DRIVER	One (1) 1.75A, Class A (sound), Class II (isolation) driver. 120VAC (nominal) primary input voltage. 50/60Hz. >0.90 Power Factor, 20% THD (nominal at 120VAC full load). Output over-voltage, over-current, and short circuit protection.
PHYSICAL	ROUND CAMLOCK CANOPY (RECESSED JUNCTION BOX)	5" dia., machined aluminum construction. Includes stainless steel universal mounting ring for use with 4" octagonal junction box. Two (2) tamper-resistant, black oxide stainless steel mounting screws. 1/8" thick HT-805A silicone foam gasket for water-tight seal. Integral Camlock provides additional 30° adjustment for precision alignment of UPM regardless of junction box orientation. Integral wiper seal maintains water-tight integrity between UPM and junction box. Optional stainless steel mounting brackets may be specified to provide additional anchor to architectural surface.
	RECTANGULAR CAMLOCK CANOPY (RECESSED JUNCTION BOX)	Copper free, aluminum extrusion with die cast end caps. Surface mounted with flow through back channel to prevent water and debris collection. Machined aluminum cover with countersunk holes for flush hardware installation. Tamper-resistant, captive, black oxide stainless steel mounting screws. Front access for ease of installation and inspection. Two (2) 1/2" NPT female conduit entries per end cap for through wiring.
	HOUSING	Copper free, aluminum extrusion with die cast end caps. Surface mounted with flow through back channel to prevent water and debris collection. Machined aluminum cover with countersunk holes for flush hardware installation. Tamper-resistant, captive, black oxide stainless steel mounting screws. Front access for ease of installation and inspection. Two (2) 1/2" NPT female conduit entries per end cap for through wiring.
	INSTALLATION TETHER	Stainless steel cable with integral loop allows cover to temporarily suspend from housing during installation to simplify wire connection and component attachment.
	PATENTED KNOCKOUTS	Four (4) 1/2" NPT, machined aluminum knockouts. High temperature, silicone 'O' Ring for water-tight seal. Patented design allows knockout to be reinserted without compromising seal integrity.
	FINISH	StarGuard, our 15-stage, chromate-free process cleans and conversion coats aluminum components prior to application of Class 'A' TGIC polyester powder coating and is RoHS compliant. Finish to match fixture. (specified separately).
	WARRANTY	5-year limited warranty.
  	CERTIFICATION & LISTING	Certified to CAN/CSA/ANSI Standards. UL Listed. NEMA 4X / IP66 Rated Enclosure. RoHs compliant. Made in USA with sustainable processes.

**B-K LIGHTING**

**MADE IN THE USA**

559.438.5800 | INFO@BKLIGHTING.COM | BKLIGHTING.COM

**DENALI - PM2DRM DRIVER HOUSING (BLUETOOTH - TREE STRAP) ORDER FIXTURE SEPARATELY.**

DATE:	PROJECT:	TYPE:
-------	----------	-------

CATALOG NUMBER LOGIC:

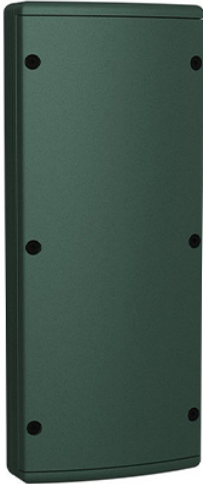

*\*Requires 2 sets of 0-10V controls. Sold separately.*

*\*\*Bluetooth control system requirements. For use with iPod Touch 5 or later, Mini iPad, iPad3 (2012) or later or iPhone 4S or later.*

**CATALOG NUMBER LOGIC**

Example: PM2DRM - TSC-20 - BT - SAP -MT - MB

**MATERIAL**

Aluminum

**SERIES**

PM2DRM - Universal Power Module 2 Dual Remote

**MOUNTING**

TS-Length - Tree Strap (Specify adjustable strap length) 18" Standard Min.

**CONTROL**

010 - 0-10V Wired Installation\*

BT - Bluetooth (See requirements)\*\*

**FINISH**

Standard Finishes (BZP, BZW, BLP, BLW, WHP, WHW, SAP, VER)

Premium Finish (ABP, AMG, AQW, BCM, BGE, BPP, CAP, CMG, CRI, CRM, HUG, MDS, NBP, OCP, RMG, SDS, SMG, TXF, WCP, WIR)

(Also available in RAL Finishes. See submittal SUB-1439-00)

**INPUT VOLTAGE**

MT - 120-277 VAC (For use with 20W LED color tuning fixtures)

**OPTIONS**

SC - Safety Cable for use with Tree Strap Mount. Cable length to match strap length. 18" Standard Min.

MB - Mounting Brackets

DATE: \_\_\_\_\_ PROJECT: \_\_\_\_\_ TYPE: \_\_\_\_\_

**FRONT VIEW**

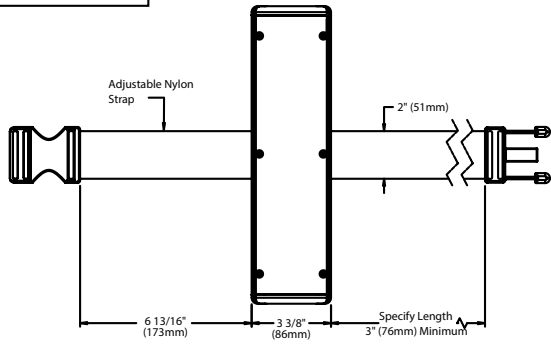

**END VIEW**



**SAFETY CABLE**

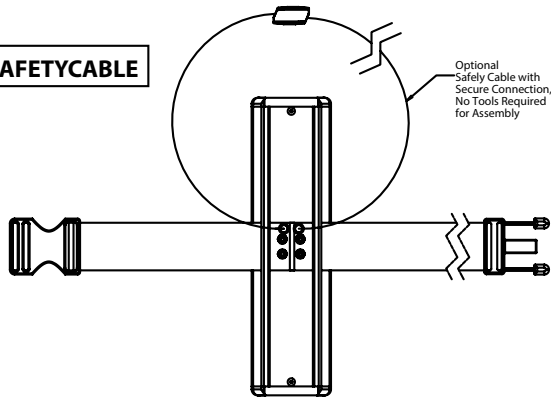

**0-10V WIRED CONTROL**

For use with: **C22 - 20WLED/1650-8000K + Dimming and CCT only**  
(0-10V Wired Installation)

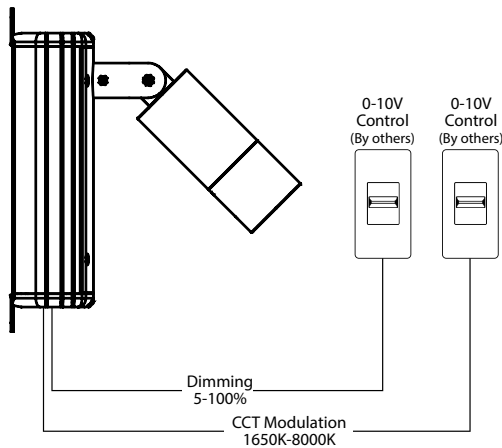

**! REMOTE WIRING**

**LED Driver**

Remote driver installations require inter-connected wiring between the LED and driver (by others). Drivers have specific wiring requirements between these components. Driver manufacturers regularly recommend the following wiring details for such installations:

- Do not exceed 50 foot overall wiring distance using 12 gauge copper wire.

**Failure to comply with specific wiring requirements will void product warranty.**

**OPTIONAL MOUNTING BRACKET**

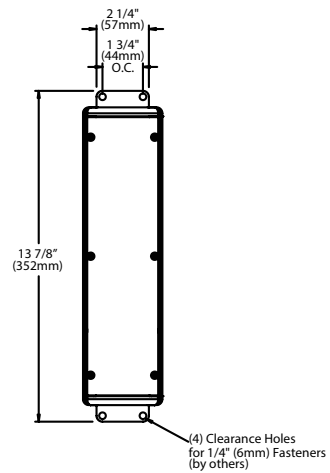

**IOS DEVICE CONTROL**

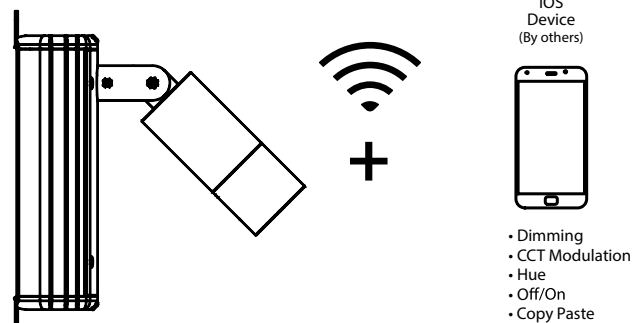

For use with: **C22 - 20WLED/1650-8000K + Saturation and Hue**  
(Bluetooth Installation)



DATE:	PROJECT:	TYPE:
-------	----------	-------

ACCESSORIES (Configure separately)

## SPECIFICATIONS

Electrical	INSPIRATION (BLUETOOTH WIRELESS TECHNOLOGY)	Wireless communication system creates dynamic lumen response at the individual fixture. Indexed (100% to 5% nom.) lumen output. Maintains output at desired level or may be changed as conditions require via exclusive mobile application. App available at the Apple App® Store. CCT modulation between 1650K through 4000K. Full saturation and hue control enables selection of any single color point off the Planckian curve for dynamic full color output. A copy/paste function permits replication of the current selection to other modules within the wireless network. Wireless control up to 5 feet.
	BLUETOOTH CONNECTIVITY REQUIREMENTS	iOS device (by others) with Inspiration Control System app is required for wireless Bluetooth® control. Works with iPhone® (4S or newer); iPad® (3rd generation or newer); iPad mini®; iPad Air®; iPod® Touch (5th generation or newer).
	0-10V WIRED CONTROL	Requires two (2) sets of 0-10V industry wired controls wired direct to the fixture. One provides CCT modulation between 1650K through 8000K in 1% increments. The second enables 5-100% dimming in 1% increments. iOS device may also be utilized to select a single color point off the Planckian curve for dynamic full color output with the remaining functions enabled by the 0-10V controls.
	DRIVER	Two (2) 1.75A, Class A (sound), Class II (isolation) drivers. 120VAC (nominal) primary input voltage. 50/60Hz. >0.90 Power Factor, 20% THD (nominal at 120VAC full load). Output over-voltage, over-current, and short circuit protection.
PHYSICAL	TREE INSTALLATION	Tree Strap mounting system facilitates non-invasive installation. Adjustable nylon strap is mold and mildew resistant and will not hinder tree growth. Stainless steel safety cable maintains UPM mounting when nylon strap is disengaged.
	HOUSING	Copper free, aluminum extrusion with die cast end caps. Surface mounted with flow through back channel to prevent water and debris collection. Machined aluminum cover with countersunk holes for flush hardware installation. Tamper-resistant, captive, black oxide stainless steel mounting screws. Front access for ease of installation and inspection. Two (2) 1/2" NPT female conduit entries per end cap for through wiring.
	INSTALLATION TETHER	Stainless steel cable with integral loop allows cover to temporarily suspend from housing during installation to simplify wire connection and component attachment.
	PATENTED KNOCKOUTS	Four (4) 1/2" NPT, machined aluminum knockouts. High temperature, silicone 'O' Ring for water-tight seal. Patented design allows knockout to be reinserted without compromising seal integrity.
	FINISH	StarGuard, our 15-stage, chromate-free process cleans and conversion coats aluminum components prior to application of Class 'A' TGIC polyester powder coating and is RoHS compliant. Finish to match fixture. (specified separately).
	WARRANTY	5-year limited warranty.
CERTIFICATION & LISTING	Certified to CAN/CSA/ANSI Standards. UL Listed. NEMA 4X / IP66 Rated Enclosure. RoHs compliant. Made in USA with sustainable processes.	
  		

DATE:	PROJECT:	TYPE:
-------	----------	-------

CATALOG NUMBER LOGIC:

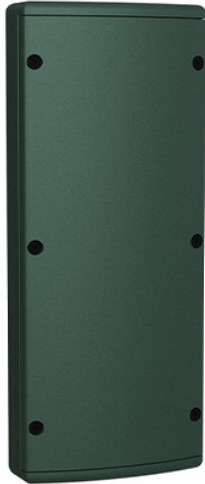

*\*Requires 2 sets of 0-10V controls. Sold separately.*

*\*\*Bluetooth control system requirements. For use with iPod Touch 5 or later, Mini iPad, iPad3 (2012) or later or iPhone 4S or later.*

**CATALOG NUMBER LOGIC**

Example: PM2DRM - SM - BT - SAP - MT

**MATERIAL**

Aluminum

**SERIES**

PM2DRM - Universal Power Module 2 Dual Remote

**MOUNTING**

SM - Surface Mount

**CONTROL**

010 - 0-10V Wired Installation\*

BT - Bluetooth (See requirements)\*\*

**FINISH**

Standard Finishes (BZP, BZW, BLP, BLW, WHP, WHW, SAP, VER)

Premium Finish (ABP, AMG, AQW, BCM, BGE, BPP, CAP, CMG, CRI, CRM, HUG, MDS, NBP, OCP, RMG, SDS, SMG, TXF, WCP, WIR)

(Also available in RAL Finishes. See submittal SUB-1439-00)

**INPUT VOLTAGE**

MT - 120-277 VAC (For use with 20W LED color tuning fixtures)

DATE:

PROJECT:

TYPE:

**! REMOTEWIRING**

**END VIEW**

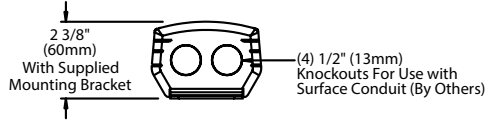

**TOP VIEW**

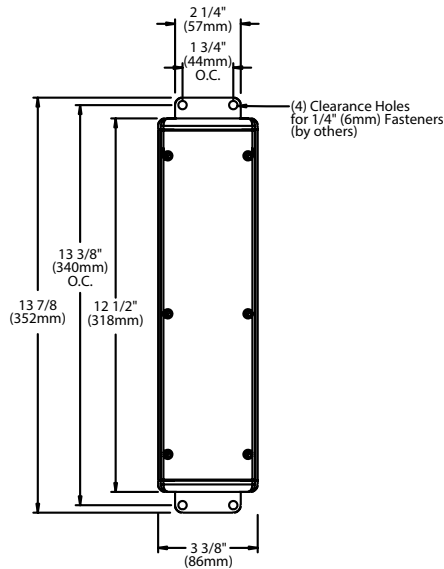

**SIDEVIEW**

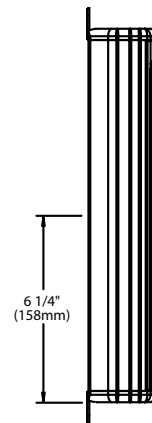

**LED Driver**

Remote driver installations require inter-connected wiring between the LED and driver (by others). Drivers have specific wiring requirements between these components. Driver manufacturers regularly recommend the following wiring details for such installations:

- Do not exceed 50 foot overall wiring distance using 12 gauge copper wire.

**Failure to comply with specific wiring requirements will void product warranty.**

**0-10V WIRED CONTROL**

For use with: **C22 - 20WLED/1650-8000K + Dimming and CCT only**  
(0-10V Wired Installation)

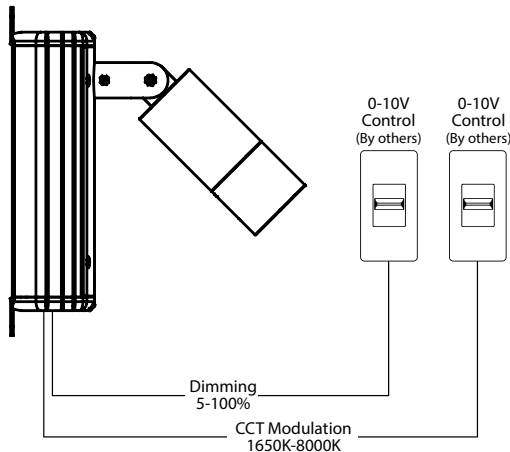

**IOS DEVICE CONTROL**

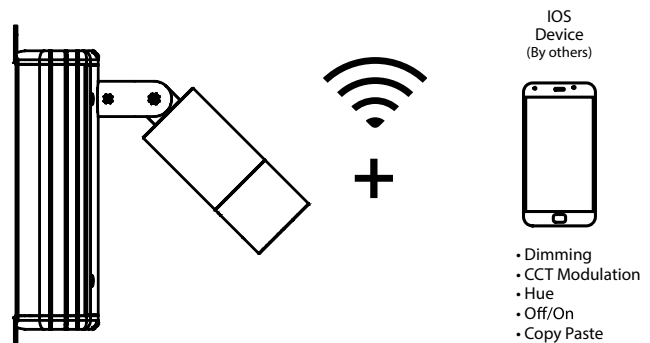

For use with: **C22 - 20WLED/1650-8000K + Saturation and Hue**  
(Bluetooth Installation)



DATE:	PROJECT:	TYPE:
-------	----------	-------

ACCESSORIES (Configure separately)

## SPECIFICATIONS

Electrical	INSPIRATION (BLUETOOTH WIRELESS TECHNOLOGY)	Wireless communication system creates dynamic lumen response at the individual fixture. Indexed (100% to 5% nom.) lumen output. Maintains output at desired level or may be changed as conditions require via exclusive mobile application. App available at the Apple App® Store. CCT modulation between 1650K through 4000K. Full saturation and hue control enables selection of any single color point off the Planckian curve for dynamic full color output. A copy/paste function permits replication of the current selection to other modules within the wireless network. Wireless control up to 5 feet.
	BLUETOOTH CONNECTIVITY REQUIREMENTS	iOS device (by others) with Inspiration Control System app is required for wireless Bluetooth® control. Works with iPhone® (4S or newer); iPad® (3rd generation or newer); iPad mini®; iPad Air®; iPod® Touch (5th generation or newer).
	0-10V WIRED CONTROL	Requires two (2) sets of 0-10V industry wired controls wired direct to the fixture. One provides CCT modulation between 1650K through 8000K in 1% increments. The second enables 5-100% dimming in 1% increments. iOS device may also be utilized to select a single color point off the Planckian curve for dynamic full color output with the remaining functions enabled by the 0-10V controls.
	DRIVER	Two (2) 1.75A, Class A (sound), Class II (isolation) drivers. 120VAC (nominal) primary input voltage. 50/60Hz. >0.90 Power Factor, 20% THD (nominal at 120VAC full load). Output over-voltage, over-current, and short circuit protection.
PHYSICAL	SURFACE MOUNT	For use with side entry, surface conduits. Stainless steel mounting brackets provide for direct anchor to architectural surfaces in any orientation.
	HOUSING	Copper free, aluminum extrusion with die cast end caps. Surface mounted with flow through back channel to prevent water and debris collection. Machined aluminum cover with countersunk holes for flush hardware installation. Tamper-resistant, captive, black oxide stainless steel mounting screws. Front access for ease of installation and inspection. Two (2) 1/2" NPT female conduit entries per end cap for through wiring.
	INSTALLATION TETHER	Stainless steel cable with integral loop allows cover to temporarily suspend from housing during installation to simplify wire connection and component attachment.
	PATENTED KNOCKOUTS	Four (4) 1/2" NPT, machined aluminum knockouts. High temperature, silicone 'O' Ring for water-tight seal. Patented design allows knockout to be reinserted without compromising seal integrity.
	FINISH	StarGuard, our 15-stage, chromate-free process cleans and conversion coats aluminum components prior to application of Class 'A' TGIC polyester powder coating and is RoHS compliant. Finish to match fixture. (specified separately).
	WARRANTY CERTIFICATION & LISTING	5-year limited warranty. Certified to CAN/CSA/ANSI Standards. UL Listed. NEMA 4X / IP66 Rated Enclosure. RoHs compliant. Made in USA with sustainable processes.
  		

**B-K LIGHTING**
**MADE IN THE USA**

 559.438.5800 | [INFO@BKLIGHTING.COM](mailto:INFO@BKLIGHTING.COM) | [BKLIGHTING.COM](http://BKLIGHTING.COM)

DATE:	PROJECT:	TYPE:
-------	----------	-------

CATALOG NUMBER LOGIC:

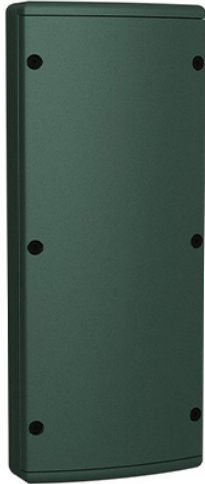

*\*Requires 2 sets of 0-10V controls. Sold separately.*

*\*\*Bluetooth control system requirements. For use with iPod Touch 5 or later, Mini iPad, iPad3 (2012) or later or iPhone 4S or later.*

**CATALOG NUMBER LOGIC**

Example: PM2DRM - CR - BT - SAP -MT - MB

**MATERIAL**

Aluminum

**SERIES**

PM2DRM - Universal Power Module 2 Dual Remote

**MOUNTING**

CR - Round Camlock Canopy (Recessed Junction Box)

CT - Rectangular Camlock Canopy (Recessed Junction Box)

**CONTROL**

010 - 0-10V Wired Installation\*

BT - Bluetooth (See requirements)\*\*

**FINISH**

Standard Finishes (BZP, BZW, BLP, BLW, WHP, WHW, SAP, VER)

Premium Finish (ABP, AMG, AQW, BCM, BGE, BPP, CAP, CMG, CRI, CRM, HUG, MDS, NBP, OCP, RMG, SDS, SMG, TXF, WCP, WIR)

(Also available in RAL Finishes. See submittal SUB-1439-00)

**INPUT VOLTAGE**

MT - 120-277 VAC (For use with 20W LED color tuning fixtures)

**OPTIONS**

MB - Mounting Brackets



DATE: PROJECT: TYPE:

TOP VIEW

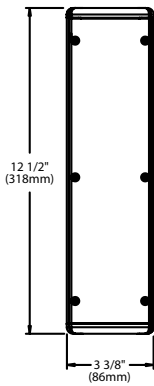

SIDEVIEW

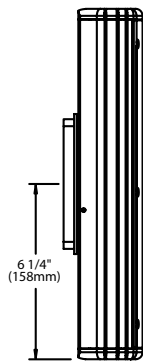

**! REMOTEWIRING**

**LED Driver**

Remote driver installations require inter-connected wiring between the LED and driver (by others). Drivers have specific wiring requirements between these components. Driver manufacturers regularly recommend the following wiring details for such installations:

- Do not exceed 50 foot overall wiring distance using 12 gauge copper wire.

**Failure to comply with specific wiring requirements will void product warranty.**

OPTIONAL MOUNTING BRACKET

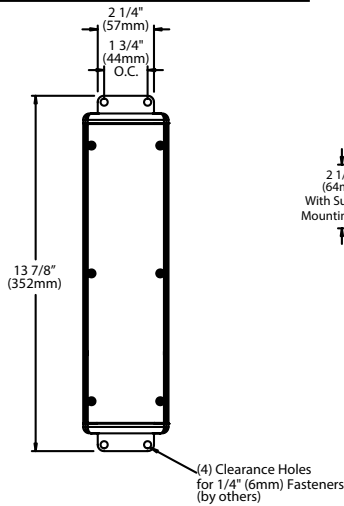

END VIEW



RECTANGULAR CAMLOCK™ CANOPY

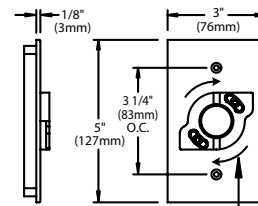

ROUND CAMLOCK™ CANOPY

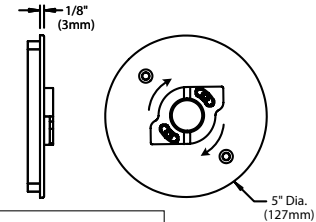

0-10V WIRED CONTROL

For use with: **C22 - 20WLED/1650-8000K + Dimming and CCT only**  
(0-10V Wired Installation)

IOS DEVICE CONTROL

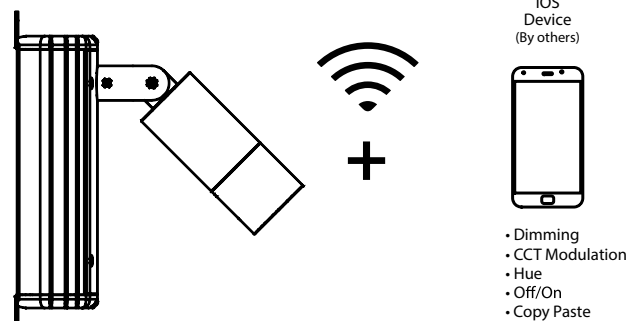
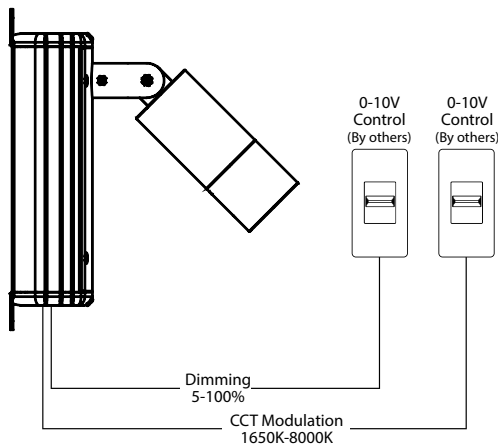

For use with: **C22 - 20WLED/1650-8000K + Saturation and Hue**  
(Bluetooth Installation)



DATE:	PROJECT:	TYPE:
-------	----------	-------

ACCESSORIES (Configure separately)

## SPECIFICATIONS

Electrical	INSPIRATION (BLUETOOTH WIRELESS TECHNOLOGY)	Wireless communication system creates dynamic lumen response at the individual fixture. Indexed (100% to 5% nom.) lumen output. Maintains output at desired level or may be changed as conditions require via exclusive mobile application. App available at the Apple App® Store. CCT modulation between 1650K through 4000K. Full saturation and hue control enables selection of any single color point off the Planckian curve for dynamic full color output. A copy/paste function permits replication of the current selection to other modules within the wireless network. Wireless control up to 5 feet.
	BLUETOOTH CONNECTIVITY REQUIREMENTS	iOS device (by others) with Inspiration Control System app is required for wireless Bluetooth® control. Works with iPhone® (4S or newer); iPad® (3rd generation or newer); iPad mini®; iPad Air®; iPod® Touch (5th generation or newer).
	0-10V WIRED CONTROL	Requires two (2) sets of 0-10V industry wired controls wired direct to the fixture. One provides CCT modulation between 1650K through 8000K in 1% increments. The second enables 5-100% dimming in 1% increments. iOS device may also be utilized to select a single color point off the Planckian curve for dynamic full color output with the remaining functions enabled by the 0-10V controls.
	DRIVER	Two (2) 1.75A, Class A (sound), Class II (isolation) drivers. 120VAC (nominal) primary input voltage. 50/60Hz. >0.90 Power Factor, 20% THD (nominal at 120VAC full load). Output over-voltage, over-current, and short circuit protection.
PHYSICAL	ROUND CAMLOCK CANOPY (RECESSED JUNCTION BOX)	5" dia., machined aluminum construction. Includes stainless steel universal mounting ring for use with 4" octagonal junction box. Two (2) tamper-resistant, black oxide stainless steel mounting screws. 1/8" thick HT-805A silicone foam gasket for water-tight seal. Integral Camlock provides additional 30° adjustment for precision alignment of UPM regardless of junction box orientation. Integral wiper seal maintains water-tight integrity between UPM and junction box. Optional stainless steel mounting brackets may be specified to provide additional anchor to architectural surface.
	RECTANGULAR CAMLOCK CANOPY (RECESSED JUNCTION BOX)	Copper free, aluminum extrusion with die cast end caps. Surface mounted with flow through back channel to prevent water and debris collection. Machined aluminum cover with countersunk holes for flush hardware installation. Tamper-resistant, captive, black oxide stainless steel mounting screws. Front access for ease of installation and inspection. Two (2) 1/2" NPT female conduit entries per end cap for through wiring.
	HOUSING	Copper free, aluminum extrusion with die cast end caps. Surface mounted with flow through back channel to prevent water and debris collection. Machined aluminum cover with countersunk holes for flush hardware installation. Tamper-resistant, captive, black oxide stainless steel mounting screws. Front access for ease of installation and inspection. Two (2) 1/2" NPT female conduit entries per end cap for through wiring.
	INSTALLATION TETHER	Stainless steel cable with integral loop allows cover to temporarily suspend from housing during installation to simplify wire connection and component attachment.
	PATENTED KNOCKOUTS	Four (4) 1/2" NPT, machined aluminum knockouts. High temperature, silicone 'O' Ring for water-tight seal. Patented design allows knockout to be reinserted without compromising seal integrity.
	FINISH	StarGuard, our 15-stage, chromate-free process cleans and conversion coats aluminum components prior to application of Class 'A' TGIC polyester powder coating and is RoHS compliant. Finish to match fixture. (specified separately).
	WARRANTY	5-year limited warranty.
  	CERTIFICATION & LISTING	Certified to CAN/CSA/ANSI Standards. UL Listed. NEMA 4X / IP66 Rated Enclosure. RoHS compliant. Made in USA with sustainable processes.