

Transformer Installation Instructions



Warning



High Voltage



Hot Surface

NEEDED FOR INSTALLATION:		1/8" Allen Wrench
		Waterproof Wire Connectors
		Level
		Phillips Screwdriver
		7/8" Hole Saw

INSTRUCTIONS PERTAINING TO A RISK OF FIRE, OR INJURY TO PERSONS IMPORTANT SAFETY INSTRUCTIONS

Lighted fixture is HOT!
WARNING - To reduce the risk of FIRE OR INJURY TO PERSONS:
 Turn off/unplug and allow to cool before replacing LED. Fixture gets HOT quickly! Contact only switch/plug when turning on. Do not touch hot lens, guard, or enclosure. Keep fixture away from materials that may burn. Do not operate the luminaire fitting with a missing or damaged shield. Do not touch the source at any time. Use a soft cloth or gloves. Oil from skin may cause damage.

SAVE THESE INSTRUCTIONS

IMPORTANT SAFETY INFORMATION - READ, FOLLOW, AND SAVE ALL SAFETY AND INSTALLATION INSTRUCTIONS

- Product must be installed by a qualified person in a manner consistent with its intended use and in compliance with the National Electrical Code, Canadian Electrical Code, and all Local and Provincial Codes.
- Follow product label information and instructions.
- Qualified Personnel with appropriate personal protective equipment must perform all servicing of this product.
- Before wiring to power supply and during servicing, turn off and lock out power at fuse or circuit breaker before service.
- The use of accessory equipment not recommended by the manufacturer or installed contrary to instructions may cause an unsafe condition. The use of damaged components may cause an unsafe condition and void product warranty.
- Do not block light emanating from product in whole or part, as this may cause an unsafe condition.
- Never operate the fixture with missing or damaged lens. Lens must be cleaned on regular basis.
- Entire fixture may become extremely hot. Do not touch hot lens or fixture body.
- Replace LED assembly only with correct wattage and type of power supply appropriate for LED assembly.
- All gaskets, o-rings and sealing surfaces must be kept clean during installation and service; failure to do this may cause an unsafe condition and void product warranty.

IMPORTANT LISTINGS AND CERTIFICATIONS

• Suitable for wet locations • Suitable for recessed in ground locations

Proper soil preparation is recommended before installation. See the DIG-IT guide at www.bklighting.com/collaterals/install/digit.pdf for more information.

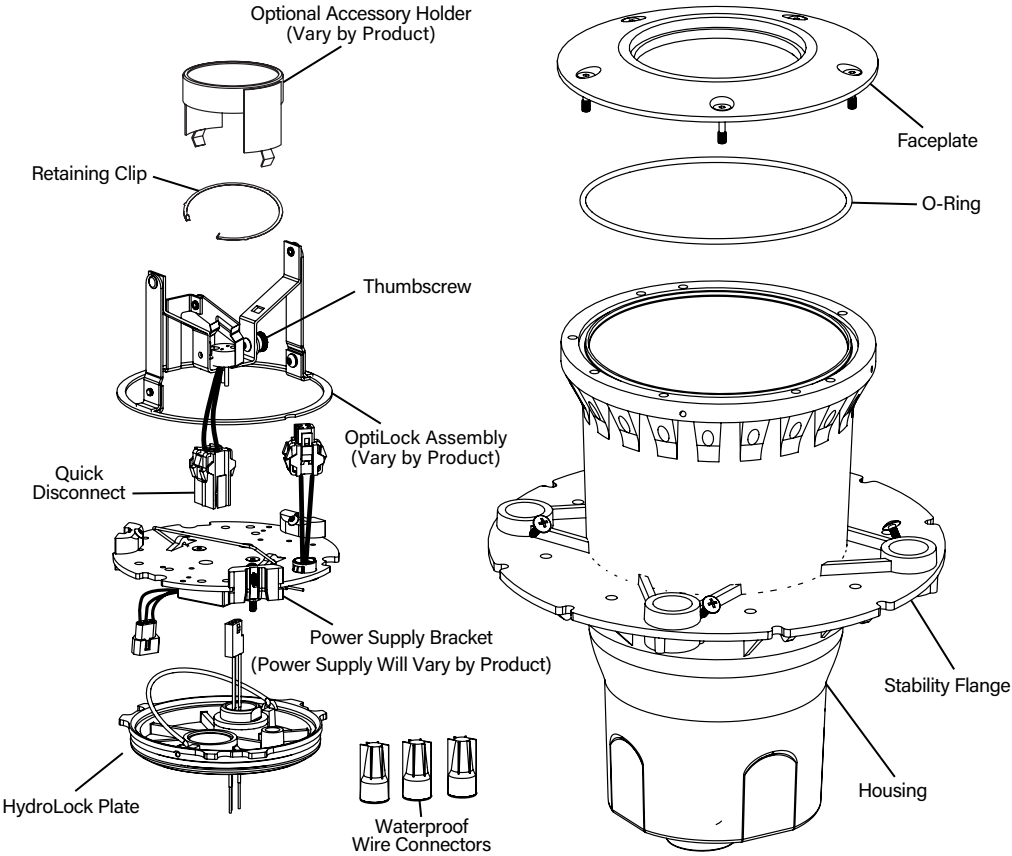

Soil Prep

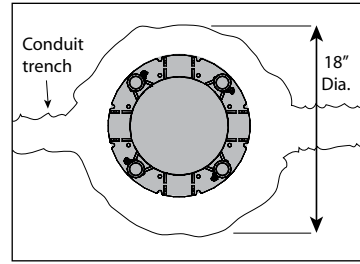

- Determine Soil Type by referencing DIG-IT Guide.
- Dig hole 18" wide and 20" deep.

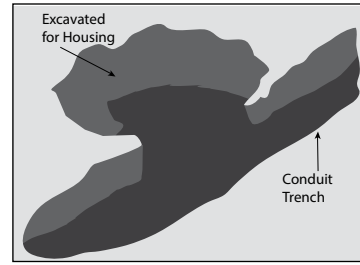

C. Prep soil according to DIG-IT Guide.

IMPORTANT SAFETY INFORMATION - READ, FOLLOW, AND SAVE THESE INSTALLATION INSTRUCTIONS

B-K LIGHTING	40429 Brickyard Drive • Madera, CA 93636 • USA 559.438.5800 • FAX 559.438.5900 www.bklighting.com • info@bklighting.com	RELEASE DATE	REFERENCE NUMBER
		10/13/2021	INS-2857-00

THIS DOCUMENT CONTAINS PROPRIETARY INFORMATION OF B-K LIGHTING, INC. AND ITS RECEIPT OR POSSESSION DOES NOT CONVEY ANY RIGHTS TO REPRODUCE, DISCLOSE ITS CONTENTS, OR TO MANUFACTURE, USE OR SELL ANYTHING IT MAY DESCRIBE. REPRODUCTION, DISCLOSURE OR USE WITHOUT SPECIFIC WRITTEN AUTHORIZATION OF B-K LIGHTING, INC. IS STRICTLY FORBIDDEN.

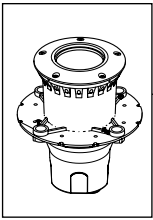

Transformer Installation Instructions

Housing Installation

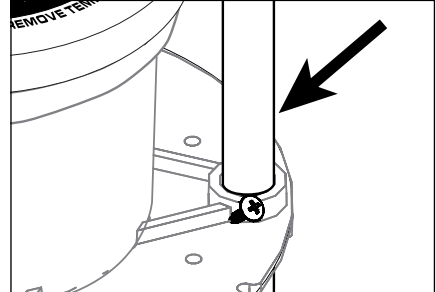
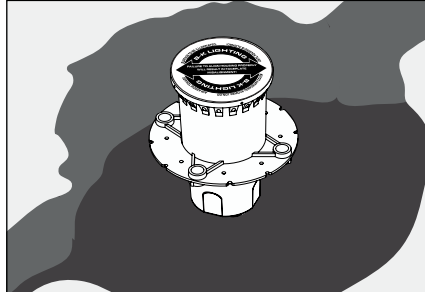
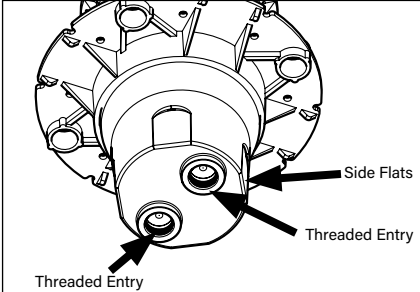

1. Connect branch conduit connectors (not included) to the junction box using either the threaded conduit entries on the bottom of the junction box or through holes drilled into the sides of the junction box.
2. Place housing in hole. Align junction box in the path of the conduit trench.
3. Insert four (4) pieces of 1/2" EMT conduit through the Stability Flange. Hammer into substrate until secure.

⚠️ Recommend 7/8" drill bit for side installation.

⚠️ Leave sufficient clearance to elevate housing to finished grade.

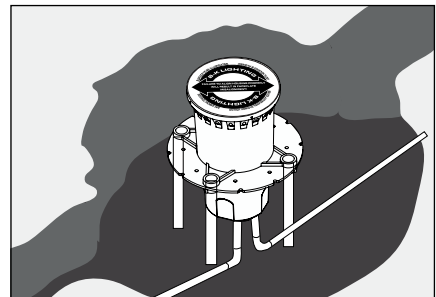
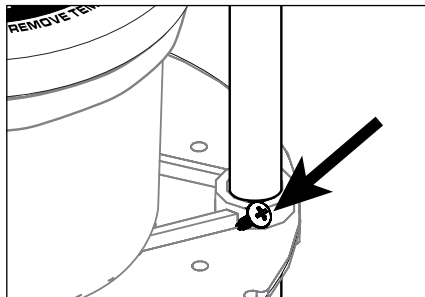
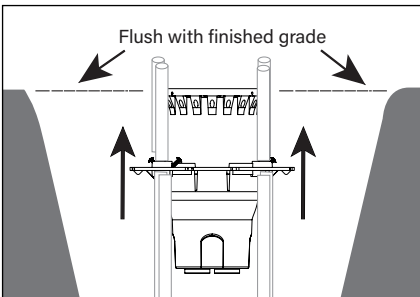

4. Raise housing on EMT so housing is flush with finished grade. Use a level to aid in housing installation.
5. When housing is level, tighten screws on Stability Flange to secure housing to EMT. Remove excess EMT as needed.
6. Pull primary branch circuit wiring into junction box.

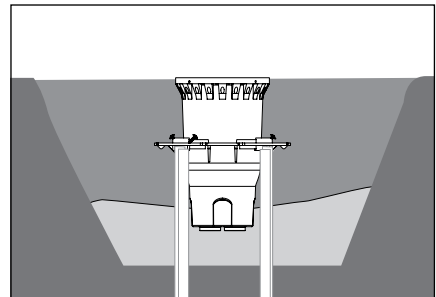
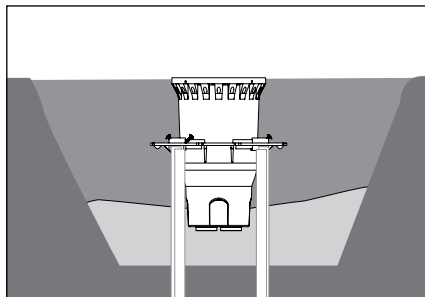
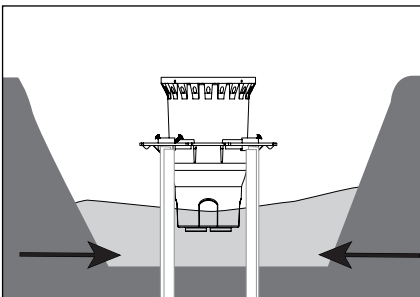

7. Per DIG-IT Guide, backfill the gap between the bottom of housing and bottom of hole with sand for drainage.
8. **For soil installation:** Fill and tamp soil to the appropriate height leaving room for sod, pavers, etc. to be level with the top of the temporary cover.
9. **For concrete installation:** Fill the hole around the fixture housing to 12" below the finished grade with clean fill dirt and tamp carefully to prevent settling of fixture. Pour concrete and finish as required flush with the top surface of the temporary cover.

⚠️ Soil installation is not drive-over rated.

**IMPORTANT SAFETY INFORMATION LISTED ON REVERSE
READ, FOLLOW, AND SAVE ALL SAFETY AND INSTALLATION INSTRUCTIONS**



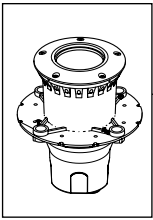

Transformer Installation Instructions

Installation

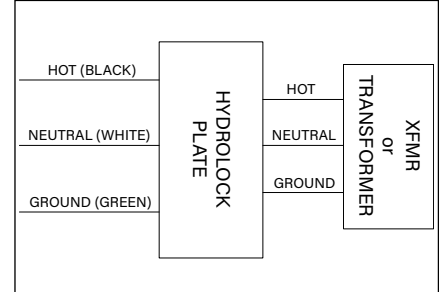
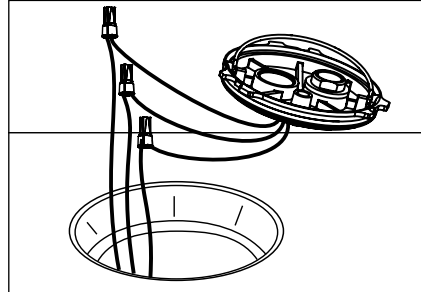

1. Remove temporary cover.

2. Make watertight connections using waterproof wire connectors (provided) to leads on the bottom of Patented HydroLock Barrier Plate Assembly. **See wiring diagram.**

WIRING DIAGRAM FOR USE WITH:

- MR16
- PAR36/AR111

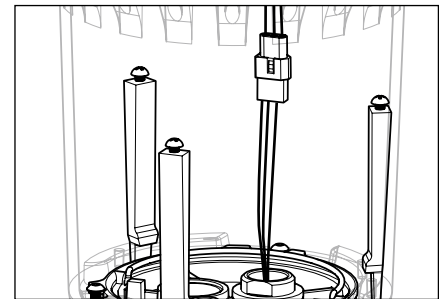
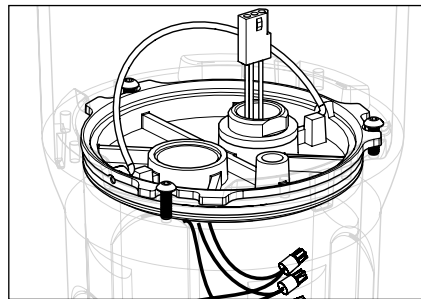
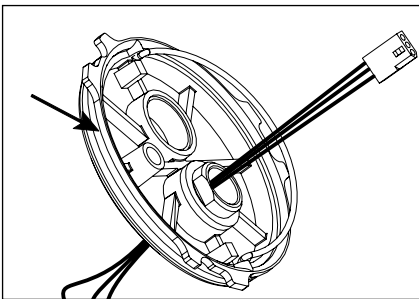

3. Wipe inside of housing where HydroLock plate will sit clean of debris before inserting patented HydroLock plate on to junction box. Align HydroLock plate with pins in housing and seat it firmly in place.

4. Turn HydroLock Barrier Plate clockwise 1/4" to lock.

5. Connect transformer assembly to Patented HydroLock Barrier plate with quick disconnect.

⚠ Patented HydroLock Barrier Plate must be completely seated to ensure proper seal or water may intrude. This step must be done as stated or you will void your warranty.

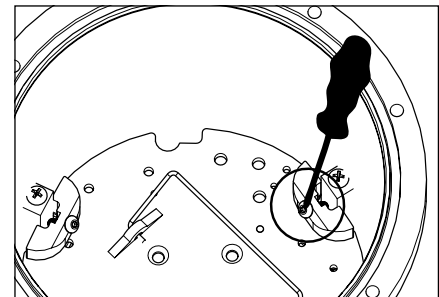
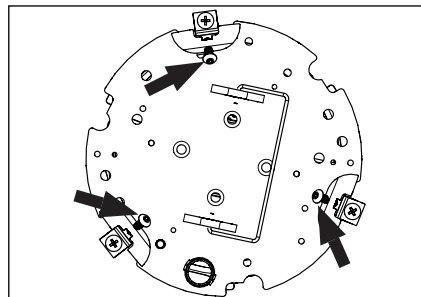
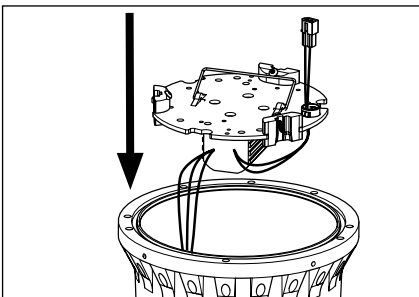

6. Lower transformer assembly into CO2 housing.

7. Line up transformer plate to posts inside the CO2 housing with slots as shown.

8. Secure transformer plate into place by tightening the three (3) #6-32 screws against the posts using a 5/64" ball driver.

**IMPORTANT SAFETY INFORMATION LISTED ON REVERSE
READ, FOLLOW, AND SAVE ALL SAFETY AND INSTALLATION INSTRUCTIONS**



Transformer Installation Instructions

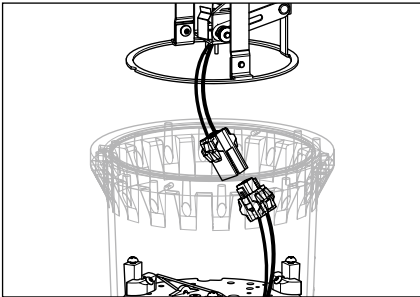
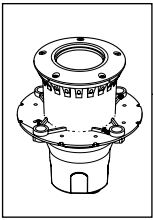

9. Connect secondary leads from transformer to OptiLock leads using pre-wired factory quick disconnect.

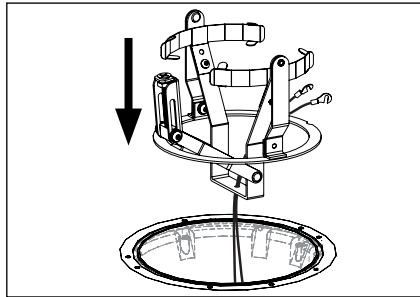

3. Place OptiLock in CO2 housing and align keyhole notch under one of three (3) #8 screw heads. Rotate horizontally to desired aiming position, then tighten two (2) #8 Phillips screws using Phillips screwdriver. Install proper MR16 halogen or PAR36/AR111 lamp according to instructions on Lamp Installation Or Re-Lamping page.

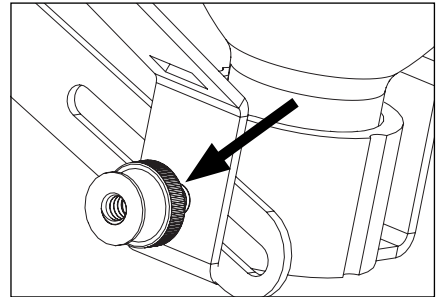

FOR USE WITH MR16

11a. Aim vertically by turning the thumbscrew on OptiLock assembly.

⚠ OptiLock vary by product.

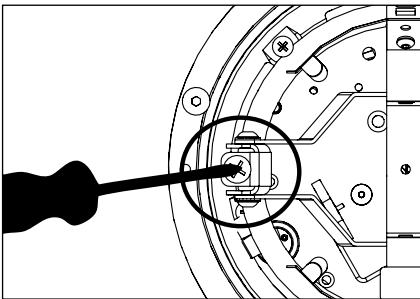

FOR USE WITH PAR36/AR111

11b. Aim vertically by turning the #10 Phillips head screw on OptiLock assembly with Phillips screwdriver.

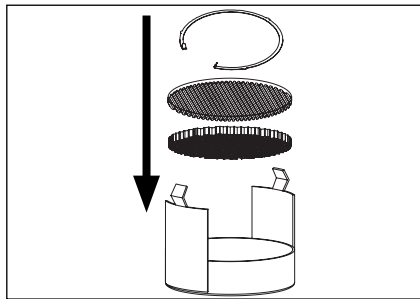

FOR USE WITH MR16

12a. Turn accessory holder upside down and remove retainer clip. Insert up to two (2) accessories. Insert the retainer clip back on.

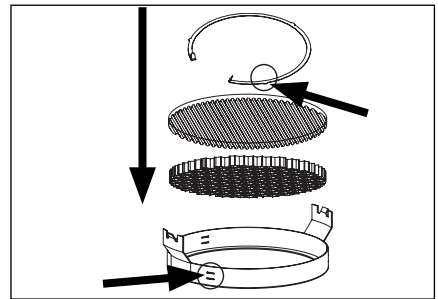

FOR USE WITH PAR36/AR111

12b. Turn accessory holder upside down and remove retainer clip. Insert up to two (2) accessories. Insert the retainer clip back on.

⚠ Insert any accessory lens with the smooth side towards the lamp. If using a honeycomb baffle, position it farthest from the lamp.

⚠ Insert any accessory lens with the smooth side towards the lamp. If using a honeycomb baffle, position it farthest from the lamp.

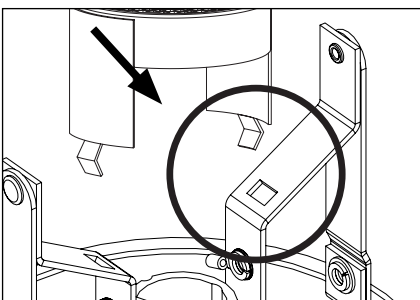

FOR USE WITH MR16

13a. **For Optional Accessory Holder:** Insert accessory holder tabs into slots on OptiLock.

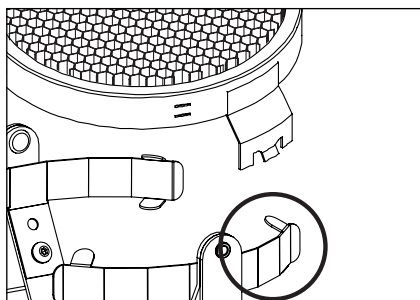

FOR USE WITH PAR36/AR111

13b. **For Optional Accessory Holder:** Insert accessory holder tabs onto arms on OptiLock.

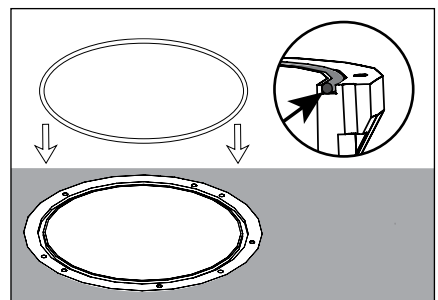

14. Remove any dirt or debris in o-ring groove near top of housing. Place o-ring inside of groove.

⚠ Failure to clean groove of debris will cause fixture to fail and void product warranty.

**IMPORTANT SAFETY INFORMATION LISTED ON REVERSE
READ, FOLLOW, AND SAVE ALL SAFETY AND INSTALLATION INSTRUCTIONS**



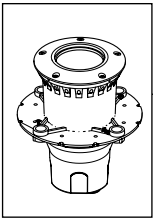

Transformer Installation Instructions

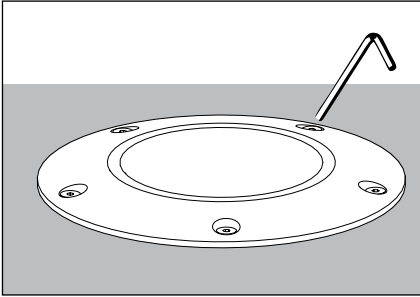

15. Install faceplate using a 1/8" allen wrench and hand-tighten the faceplate screws in a star pattern to 30 in-lbs. min.

⚠ Do not use a power tool to install screws. Do not exceed 40 in-lbs.

**IMPORTANT SAFETY INFORMATION LISTED ON REVERSE
READ, FOLLOW, AND SAVE ALL SAFETY AND INSTALLATION INSTRUCTIONS**



B-K LIGHTING

40429 Brickyard Drive • Madera, CA 93636 • USA
559.438.5800 • FAX 559.438.5900
www.bklighting.com • info@bklighting.com

RELEASE DATE
10/13/2021

REFERENCE NUMBER
INS-2857-00

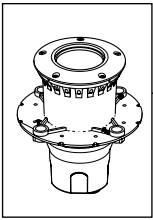

Lamp and Accessory Holder Installation



Warning



Hot Surface

**TOOLS
NEEDED:**

➤ 1/8" Allen Wrench

Lamp Installation Or Re-Lamping if Required for MR16 / ES16 Lamp

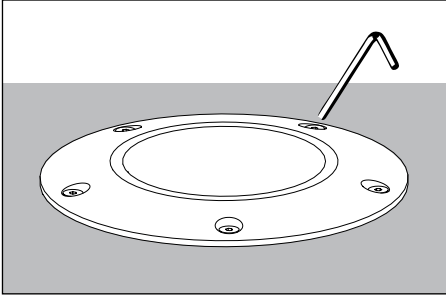

1. Remove faceplate using a 1/8" allen wrench. If there is an optional accessory holder, carefully squeeze tabs on sides and gently pull from slots on OptiLock.

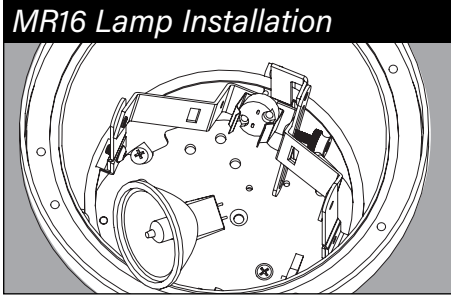

MR16 Lamp Installation

2a. Firmly insert proper MR16 lamp into socket to make connection.

⚠ **Do not exceed the maximum wattage listed on the fixture label before installing.**

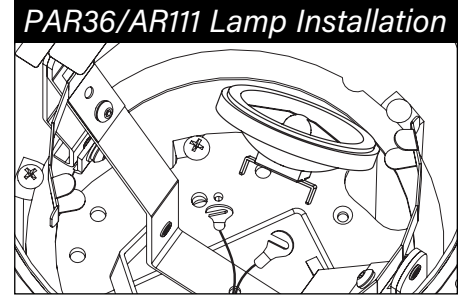

PAR36/AR111 Lamp Installation

2b. Install proper PAR36/AR111 lamp by placing connectors around loosened terminal screws, then gently tightening screw to make connection.

Do not exceed the maximum wattage listed on the fixture label before installing.

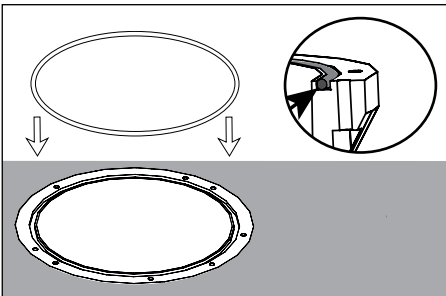

3. Remove any dirt or debris in o-ring groove near top of housing. Place o-ring inside of groove.

⚠ **Failure to clean groove of debris will cause fixture to fail and void product warranty.**

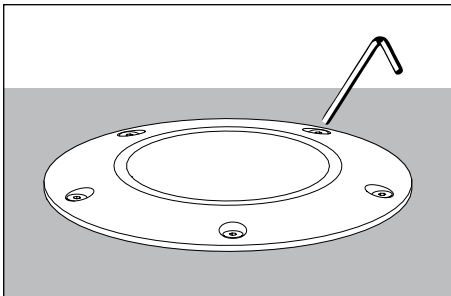

4. Install faceplate using a 1/8" allen wrench and hand-tighten the faceplate screws in a star pattern to 30 in-lbs. min.

⚠ **Do not use a power tool to install screws. Do not exceed 40 in-lbs.**

IMPORTANT SAFETY INFORMATION - READ, FOLLOW, AND SAVE THESE INSTALLATION INSTRUCTIONS

B-K LIGHTING	40429 Brickyard Drive • Madera, CA 93636 • USA 559.438.5800 • FAX 559.438.5900 www.bklighting.com • info@bklighting.com	RELEASE DATE 10/13/2021	REFERENCE NUMBER INS-2857-00
	<p><small>THIS DOCUMENT CONTAINS PROPRIETARY INFORMATION OF B-K LIGHTING, INC. AND ITS RECEIPT OR POSSESSION DOES NOT CONVEY ANY RIGHTS TO REPRODUCE, DISCLOSE ITS CONTENTS, OR TO MANUFACTURE, USE OR SELL ANYTHING IT MAY DESCRIBE. REPRODUCTION, DISCLOSURE OR USE WITHOUT SPECIFIC WRITTEN AUTHORIZATION OF B-K LIGHTING, INC. IS STRICTLY FORBIDDEN.</small></p>		