

ALPINE/ALPINE II

SURFACE DOWNLIGHT - INTEGRAL

Standard Installation



Warning







Hot Surface



High Voltage

TOOLS NEEDED:

-  3/32" Allen Wrench
-  Waterproof Wire Connectors
-  Mounting Hardware
-  Mounting Hardware for Substrate

INSTRUCTIONS PERTAINING TO A RISK OF FIRE, OR INJURY TO PERSONS IMPORTANT SAFETY INSTRUCTIONS

Lighted fixture is HOT!

WARNING - To reduce the risk of FIRE OR INJURY TO PERSONS:

Turn off/unplug and allow to cool before replacing lamp/LED. Fixture gets HOT quickly! Contact only switch/plug when turning on. Do not touch hot lens, guard, or enclosure. Keep fixture away from materials that may burn. Do not operate the luminaire fitting with a missing or damaged shield. Do not touch the source at any time. Use a soft cloth or gloves. Oil from skin may cause damage.

SAVE THESE INSTRUCTIONS

IMPORTANT SAFETY INFORMATION - READ, FOLLOW, AND SAVE ALL SAFETY AND INSTALLATION INSTRUCTIONS

- Product must be installed by a qualified person in a manner consistent with its intended use and in compliance with the National Electrical Code, Canadian Electrical Code, and all Local and Provincial Codes.
- Follow product label information and instructions.
- Qualified Personnel must perform all servicing or relamping of this product.
- Before wiring to power supply and during servicing or relamping, turn off power at fuse or circuit breaker before service.
- The use of accessory equipment not recommended by the manufacturer or installed contrary to instructions may cause an unsafe condition. The use of damaged components may cause an unsafe condition and void product warranty.
- Do not block light emanating from product in whole or part, as this may cause an unsafe condition.
- Never operate the fixture with missing or damaged lens. Lens must be cleaned on regular basis.
- Entire fixture may become extremely hot. Do not touch hot lens or fixture body. Do not touch the lamp at any time. Use a clean, dry, soft cloth to handle the lamp. Oil from skin may damage the lamp and cause it to rupture.
- Replace lamp only with correct wattage and type of lamp marked on fixture label.
- All gaskets, o-rings and sealing surfaces must be kept clean during installation and service; failure to do this may cause an unsafe condition and void product warranty.

IMPORTANT LISTINGS AND CERTIFICATIONS

- Suitable for wet locations

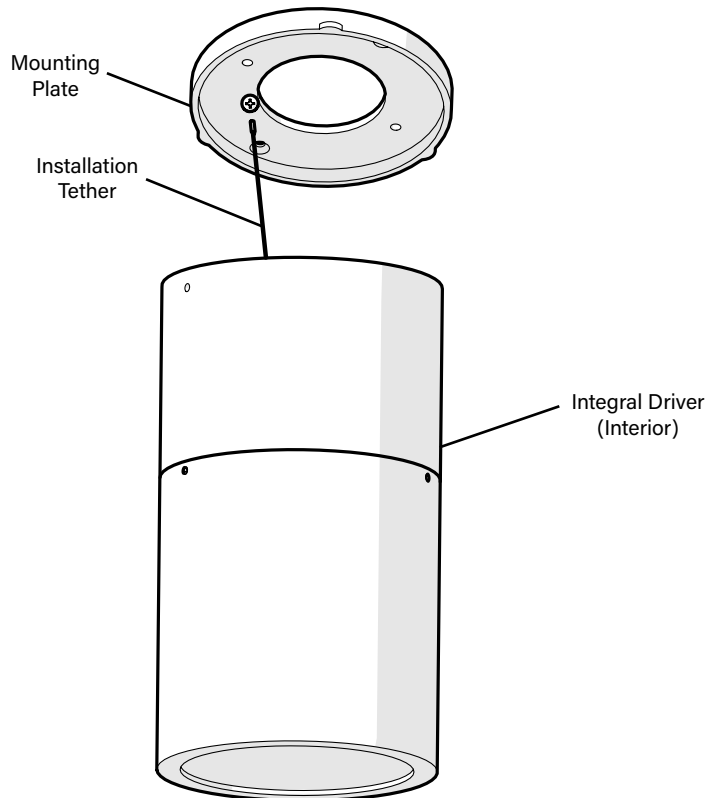

IMPORTANT SAFETY INFORMATION - READ, FOLLOW, AND SAVE THESE INSTALLATION INSTRUCTIONS

B-K LIGHTING

40429 Brickyard Drive • Madera, CA 93636 • USA
 559.438.5800 • FAX 559.438.5900
 www.bklighting.com • info@bklighting.com

RELEASE DATE
 02/28/2022

REFERENCE NUMBER
 INS-2868-00

THIS DOCUMENT CONTAINS PROPRIETARY INFORMATION OF B-K LIGHTING, INC. AND ITS RECEIPT OR POSSESSION DOES NOT CONVEY ANY RIGHTS TO REPRODUCE, DISCLOSE ITS CONTENTS, OR TO MANUFACTURE, USE OR SELL ANYTHING IT MAY DESCRIBE. REPRODUCTION, DISCLOSURE OR USE WITHOUT SPECIFIC WRITTEN AUTHORIZATION OF B-K LIGHTING, INC. IS STRICTLY FORBIDDEN.

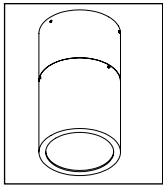

ALPINE/ALPINE II

SURFACE DOWNLIGHT - INTEGRAL

Standard Installation

Phase 1 - Rough In

Installation of Back box

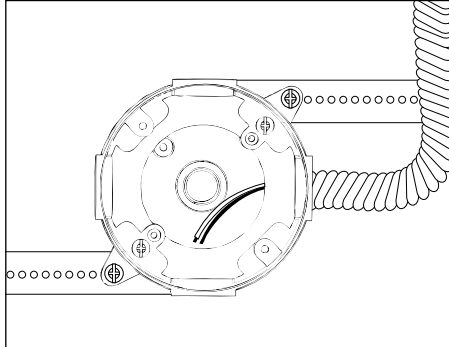

Additional Info

- Please follow National and Local electrical codes for your area.
- Use 4" round cast box.
- Suitable for through wire.
- Suitable for installation into combustible materials.
- Rated for 90° C.
- Junction box, universal mounting ring screws, box mounting hardware and gaskets.

1. Install Conduit to be used with this product.
2. Install junction box so that front face is flush with finished ceiling. Seal building envelope as per NEC.
3. Connect box to conduit and pull wires for connections (**See wiring diagram**).

Phase 2 - Finish Installation of Fixture

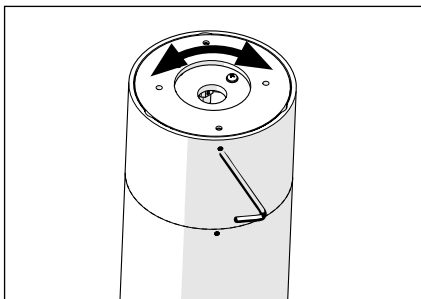

1. Remove mounting plate from fixture by rotating the mounting plate clockwise.

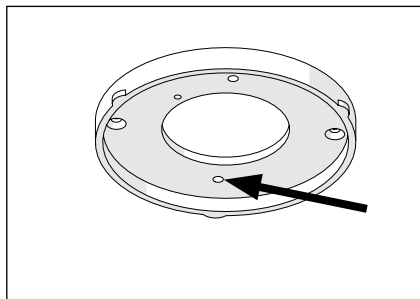

2. There are two holes for junction box mounting in mounting plate. Install mounting plate to junction box with mounting hardware (hardware not included).

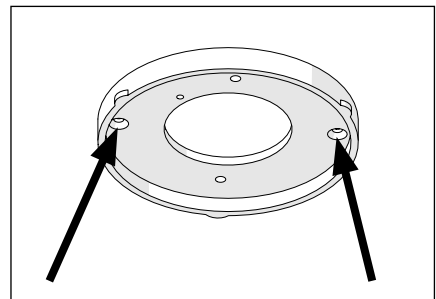

3. There are two holes for mounting the mounting plate to substrate. Secure mounting plate to substrate with mounting hardware appropriate for substrate material (hardware not included). Seal building envelope as per NEC.

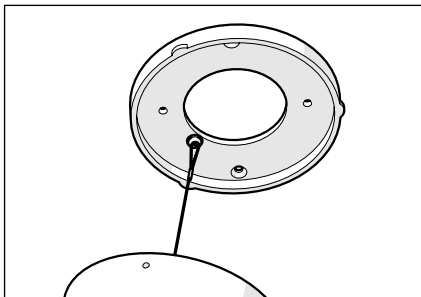

4. Slowly lower the fixture until tether is taut.

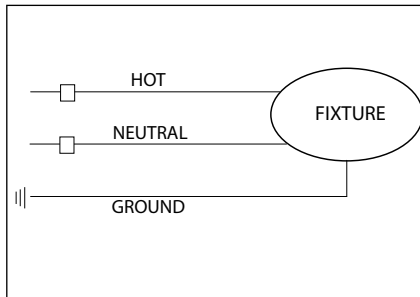

Pull branch circuit wiring. Make watertight connections from primary branch circuit to pre-wired fixture head leads using waterproof wire connectors. **See wiring diagram.**

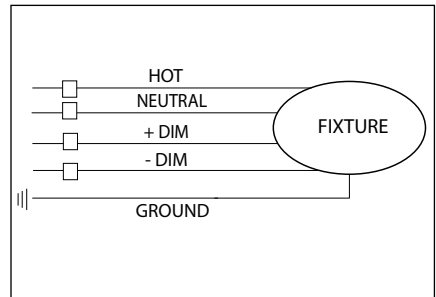

Pull branch circuit wiring. Make watertight connections from primary branch circuit to pre-wired fixture head leads using waterproof wire connectors. **See wiring diagram.**

NOTE: Installation tether supplied is designed as an installation aid and **NOT** a safety cable. Do not add weight to, or drop fixture.

**IMPORTANT SAFETY INFORMATION LISTED ON REVERSE
READ, FOLLOW, AND SAVE ALL SAFETY AND INSTALLATION INSTRUCTIONS**



B-K LIGHTING	40429 Brickyard Drive • Madera, CA 93636 • USA 559.438.5800 • FAX 559.438.5900 www.bklighting.com • info@bklighting.com	RELEASE DATE 02/28/2022	REFERENCE NUMBER INS-2868-00
	THIS DOCUMENT CONTAINS PROPRIETARY INFORMATION OF B-K LIGHTING, INC. AND ITS RECEIPT OR POSSESSION DOES NOT CONVEY ANY RIGHTS TO REPRODUCE, DISCLOSE ITS CONTENTS, OR TO MANUFACTURE, USE OR SELL ANYTHING IT MAY DESCRIBE. REPRODUCTION, DISCLOSURE OR USE WITHOUT SPECIFIC WRITTEN AUTHORIZATION OF B-K LIGHTING, INC. IS STRICTLY FORBIDDEN.		

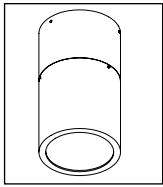

ALPINE/ALPINE II

SURFACE DOWNLIGHT - INTEGRAL

Standard Installation

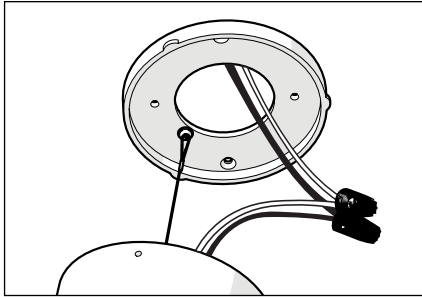

5. Pull wiring through mounting plate. Make watertight connections from primary side to fixture leads using waterproof wire connectors. **See wiring diagram.**

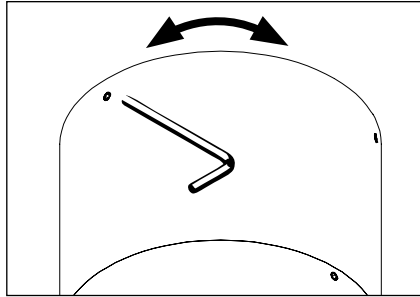

6. Place connections through wireway into junction box. Mount fixture over mounting plate, then twist lock and secure with one (1) #10-32 screws using a 3/32" allen wrench. **Do not overtighten.**

**IMPORTANT SAFETY INFORMATION LISTED ON REVERSE
READ, FOLLOW, AND SAVE ALL SAFETY AND INSTALLATION INSTRUCTIONS**



B-K LIGHTING

40429 Brickyard Drive • Madera, CA 93636 • USA
559.438.5800 • FAX 559.438.5900
www.bklighting.com • info@bklighting.com

RELEASE DATE
02/28/2022

REFERENCE NUMBER
INS-2868-00

THIS DOCUMENT CONTAINS PROPRIETARY INFORMATION OF B-K LIGHTING, INC. AND ITS RECEIPT OR POSSESSION DOES NOT CONVEY ANY RIGHTS TO REPRODUCE, DISCLOSE ITS CONTENTS, OR TO MANUFACTURE, USE OR SELL ANYTHING IT MAY DESCRIBE. REPRODUCTION, DISCLOSURE OR USE WITHOUT SPECIFIC WRITTEN AUTHORIZATION OF B-K LIGHTING, INC. IS STRICTLY FORBIDDEN.