



Warning



High Voltage

**NEEDED FOR INSTALLATION:**

-  5/32" & 5/64" Allen Wrench
-  Waterproof Wire Connectors
-  Phillips Screwdriver

By Others

**INSTRUCTIONS PERTAINING TO A RISK OF FIRE, OR INJURY TO PERSONS IMPORTANT SAFETY INSTRUCTIONS**

**Lighted fixture is HOT!**

**WARNING - To reduce the risk of FIRE OR INJURY TO PERSONS:**

Turn off/unplug and allow to cool before replacing LED. Fixture gets HOT quickly! Contact only switch/plug when turning on. Do not touch hot lens, guard, or enclosure. Keep fixture away from materials that may burn. Do not operate the luminaire fitting with a missing or damaged shield. Do not touch the source at any time. Use a soft cloth or gloves. Oil from skin may cause damage.

**SAVE THESE INSTRUCTIONS**

**IMPORTANT SAFETY INFORMATION - READ, FOLLOW, AND SAVE ALL SAFETY AND INSTALLATION INSTRUCTIONS**

- Product must be installed by a qualified person in a manner consistent with its intended use and in compliance with the National Electrical Code, Canadian Electrical Code, and all Local and Provincial Codes.
- Follow product label information and instructions.
- Qualified Personnel with appropriate personal protective equipment must perform all servicing of this product.
- Before wiring to power supply and during servicing, turn off and lock out power at fuse or circuit breaker before service.
- The use of accessory equipment not recommended by the manufacturer or installed contrary to instructions may cause an unsafe condition. The use of damaged components may cause an unsafe condition and void product warranty.
- Do not block light emanating from product in whole or part, as this may cause an unsafe condition.
- Never operate the fixture with missing or damaged lens. Lens must be cleaned on regular basis.
- Entire fixture may become extremely hot. Do not touch hot lens or fixture body.
- Replace LED assembly only with correct wattage and type of power supply appropriate for LED assembly.
- All gaskets, o-rings and sealing surfaces must be kept clean during installation and service; failure to do this may cause an unsafe condition and void product warranty.

**IMPORTANT LISTINGS AND CERTIFICATIONS**

- Suitable for wet locations • Additionally suitable for mounting within 4 ft. of the ground

**This set of instructions works for:**  
**PTR-MM-TR**  
**Mini-Micro™™**  
**For integral fixture configurations**

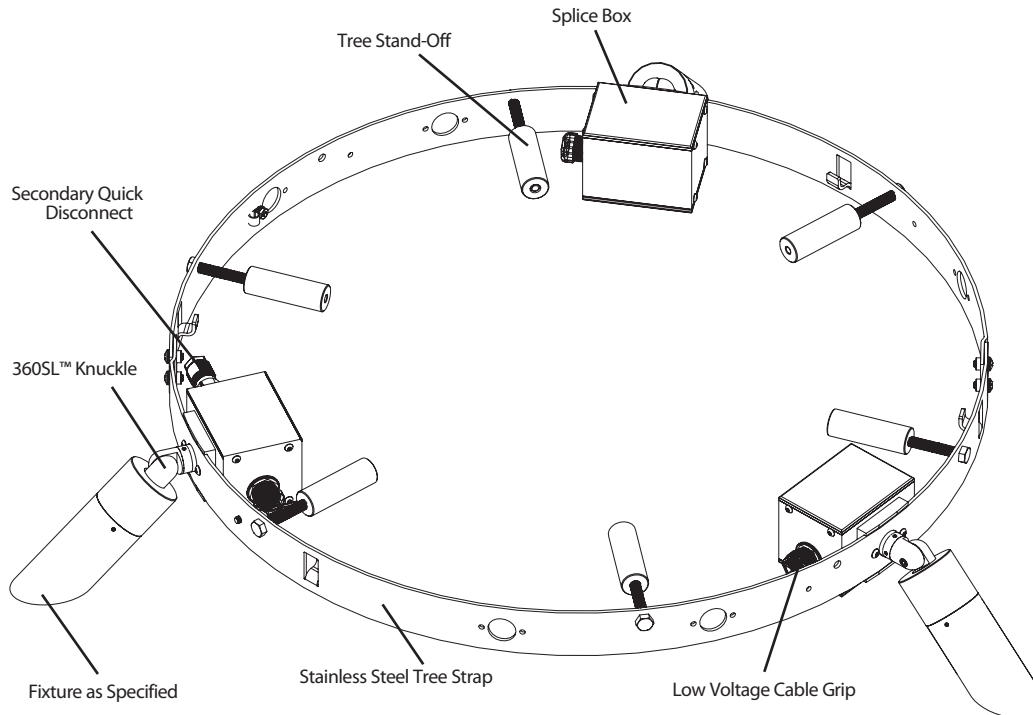

**IMPORTANT SAFETY INFORMATION - READ, FOLLOW, AND SAVE THESE INSTALLATION INSTRUCTIONS**

**B-K LIGHTING**

40429 Brickyard Drive • Madera, CA 93636 • USA  
559.438.5800 • FAX 559.438.5900  
www.bklighting.com • info@bklighting.com

RELEASED  
6-30-19

REFERENCE NUMBER  
INS-2804-00

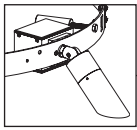

### Fixture Installation

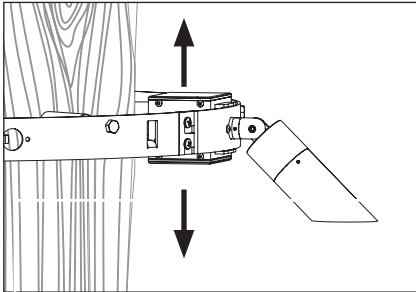

1. Place tree ring fixture around tree. Move fixture to desired height. Tighten the entire assembly to the tree with provided stand-offs.

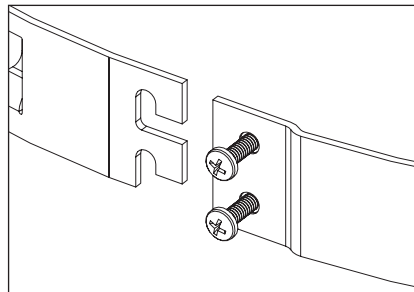

2. Secure by hooking end of strap over two (2) Phillips screws. Secure by tightening two (2) Phillips screws with Phillips screwdriver.

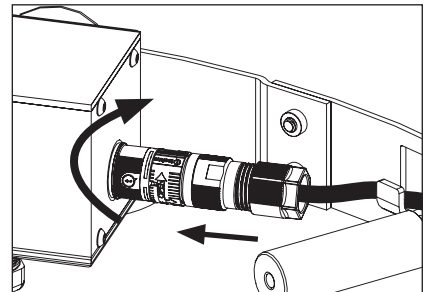

3. Connect secondary cable then twist to secure in place.

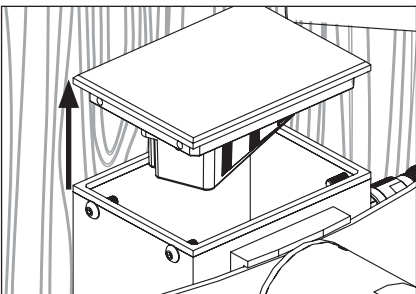

4. Remove top of transformer housing by removing (4) #8-32 set screws using 5/64" Allen wrench.

**⚠ Transformer housing will be marked for primary.**

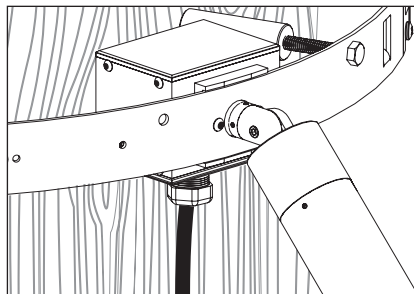

5. Bring line voltage cable from power line to main splice box location. Loosencord grip on bottom of splice box, feed linevoltage cable from power line through, then tighten cord grip to secure.

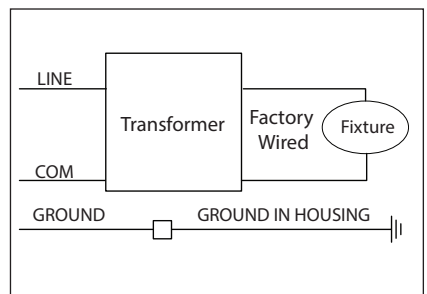

**WIRING DIAGRAM**

6. Make watertight connections from primary branch circuit to transformer with waterproof wire connectors. (By Others). Fixtures are pre-wired at factory on the secondary side. **See wiring diagram.**

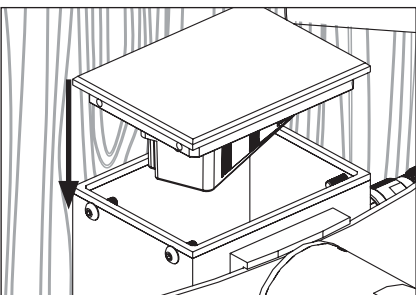

7. Replace top of transformer housing with (4) #8-32 screws with 5/64" Allen wrench.

**IMPORTANT SAFETY INFORMATION LISTED ON REVERSE  
READ, FOLLOW, AND SAVE ALL SAFETY AND INSTALLATION INSTRUCTIONS**



**B-K LIGHTING**

40429 Brickyard Drive • Madera, CA 93636 • USA  
559.438.5800 • FAX 559.438.5900  
www.bklighting.com • info@bklighting.com

RELEASED  
6-30-19

REFERENCE NUMBER  
INS-2804-00

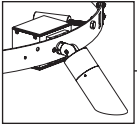

## 360SL™ Knuckle

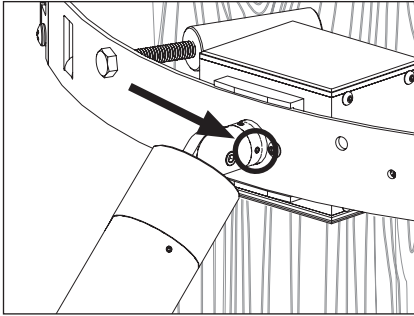

1. Use 5/64" Allen wrench to slightly loosen two (2) #8-32 stainless steel set screws on the stem for 360° aiming purpose, then tighten screws.

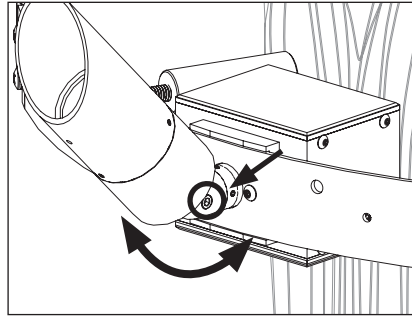

2. Rotate fixture at base and aim fixture to desired horizontal location.

3. Use 5/32" Allen wrench to loosen #10-32 stainless steel black oxide socket head cap screw at the knuckle for vertical aiming purpose, then tighten screws.

**⚠ Warning: Do not over tighten set screw. Doing so will compromise O-ring seal and will void warranty.**

**IMPORTANT SAFETY INFORMATION LISTED ON REVERSE  
READ, FOLLOW, AND SAVE ALL SAFETY AND INSTALLATION INSTRUCTIONS**



# B-K LIGHTING

40429 Brickyard Drive • Madera, CA 93636 • USA  
559.438.5800 • FAX 559.438.5900  
www.bklighting.com • info@bklighting.com

RELEASED  
6-30-19

REFERENCE NUMBER  
INS-2802-00