

DENALI - Wall Mount - Remote Driver - LED COB - Style G - Single

UPGRADED



IP66



Downloads

- Product Images (.zip)
- Technical Drawing (.zip)
- 2D (.dwg)
- 2D (.dxf)
- IES Files (.zip)
- BIM - Revit (.zip)
- Installation Instructions (.pdf)

Product Variant Examples

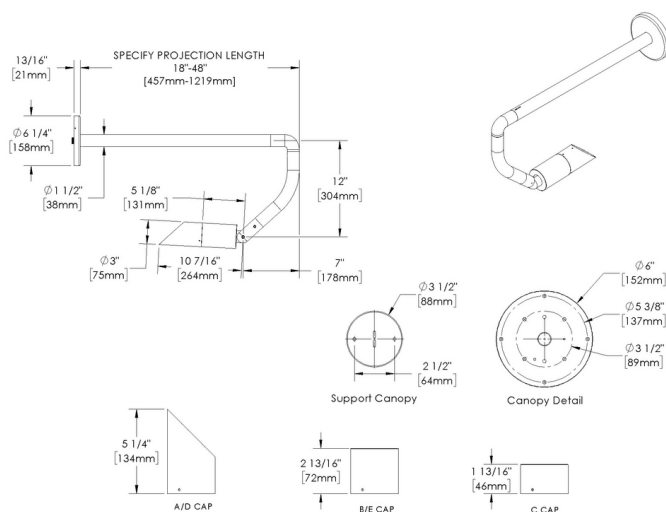

AMERICAN MADE + EMPLOYEE OWNED | 40429 Brickyard Drive, Madera, CA 93636 | +1 (559) 438-5800 | info@bklighting.com | bklighting.com

Copyright © B-K Lighting, Inc. This document contains proprietary information of B-K Lighting, inc. and its receipt or possession does not convey any rights to reproduce, disclose its contents, or to manufacture, use or sell anything it may describe.

Technical information is subject to change at the discretion of B-K Lighting Inc. For the most current technical data, please refer to bklighting.com

DENALI - Wall Mount - Remote Driver - LED COB - Style G - Single

Available Logic & Configurations

DE- 01 **WM-** 02 **RMD-** 03 **LCB-** 04 **AL-** 05 **BC14-** 06B **-** 06C **SG-F10-** 06D **-** 06F

01 SERIES

DE - DENALI

02 CATEGORY

WM - Wall Mount

03 DRIVER

RMD - Remote Driver

04 LIGHT SOURCE (TYPE)

LCB - LED COB

05 MATERIAL

AL - Aluminum

06B MOUNT

BC14 - Canopy BC14

06C STYLE

CA - Cap A - 45° (With Weephole)

CB - Cap B - 90° (With Weephole)

CC - Cap C - Flush Lens

CD - Cap D - 45°

CE - Cap E - 90°

06D VERSION

SG-F10 - Style G - Single

06F SIZE

ST24 - Stem length: 24"

ST30 - Stem length: 30"

ST36 - Stem length: 36"

ST42 - Stem length: 42"

ST48 - Stem length: 48"

- 07 **-** 08 **-** 10A **-** 10B **-** 11 **-** 12

07 LIGHT SOURCE

x58 - 2700K CRI80 - 12W (623 - 721 lm)

x59 - 3000K CRI80 - 12W (653 - 756 lm)

x60 - 4000K CRI80 - 12W (736 - 851 lm)

x61 - 2700K CRI80 - 20W (1064 - 1307 lm)

x62 - 3000K CRI80 - 20W (1120 - 1376 lm)

x63 - 4000K CRI80 - 20W (1168 - 1435 lm)

x64 - 2700K CRI80 - 27W (1383 - 1767 lm)

x65 - 3000K CRI80 - 27W (1426 - 1820 lm)

x66 - 4000K CRI80 - 27W (1506 - 1923 lm)

x67 - 2700K CRI90 - 27W (1312 - 1676 lm)

x68 - 3000K CRI90 - 27W (1394 - 1779 lm)

x69 - 3500K CRI80 - 27W (1822 - 2327 lm)

08 OPTIC

SP - Spot (15°)

MFL - Medium Flood (35°)

WFL - Wide Flood (60°)

10A LENS

09 - Clear (Standard)

12 - Soft Focus

13 - Rectilinear

10B SHIELDING

00 - Not included (Standard)

11 - Honeycomb Baffle

11 WIRING LENGTH

WL00 - Standard

WL05 - 5 Ft Leads

WL25 - 25 Ft Leads

12 FINISH

Standard Finishes

BLP, BZP, WHP, SAP, BLW, BZW, WHW, VER

Premium Finishes

CMG, SMG, RMG, AMG, TXF, BCM, BGE, WCP, OCP, HUG, ABP, BPP, SDS,

WIR, CAP, CRM, AQW, NBP

Other - RAL

RAL

Other - Custom Color

CUS

NOTE: Not all configurations may be compatible with one another. Please configure the product for specific 2D, Photometry, Downloads, Spec Sheet and Compatible mountings and power supplies.

WARNING: This is a remote driver product. Please check "Mountings With A Power Supply" or "Power Supplies" to order remote driver separately. (IMPORTANT: Driver wattage MUST match selected fixture wattage. Example: 12W Light Source = 12W Driver)

DENALI - Wall Mount - Remote Driver - LED COB - Style G - Single

Features



Anti-condensation vent allows moisture to exit the fixture but never enter in



Lens factory adhered to fixture cap providing hermetically sealed optical compartment



Manufactured in the USA with sustainable processes



Aim & Lock knuckle eliminates need for re-aiming & adjustments



Water-tight anti-siphon plug prevents moisture ingress from wireways



Secured with tamper-resistant, stainless steel hardware



Easily replaceable modular components reduce waste and extend fixture life



Slip fit cap & high temp. silicone 'O' ring provides reliable water-tight seal



Solid billet fixture body provides unmatched durability and heat management



360HD knuckle provides 360° horizontal rotation and vertical adjustment

Technical

Driver: Remote Driver

Light Source (Type): LED COB

Material: Aluminum

CCT (K): 2700, 3500, 3000, 4000

CRI: 80, 90

Input Power (W): 12, 20, 27

Delivered Lumens (lm): 623 - 2327

Beam Angle (°): 15, 35, 60

Mount: Canopy BC14

Style: Cap A - 45° (With Weephole), Cap B - 90° (With Weephole), Cap C - Flush Lens, Cap D - 45°, Cap E - 90°

Version: Style G - Single

Size: Stem length: 24", Stem length: 30", Stem length: 36", Stem length: 42", Stem length: 48"

Lens: Soft Focus, Clear (Standard), Rectilinear

Shielding: Not included (Standard), Honeycomb Baffle

Wiring Length: Standard, 5 Ft Leads, 25 Ft Leads

Finish: Standard Finishes, Premium Finishes, Other - RAL, Other - Custom Color

Body: Unibody design with enclosed, water-proof wireway, integral heat sink, fully machined from solid billet, anti-condensation and corrosion vent equalizes fixture pressure and eliminates potential for damage to internal components.

Material Detail: Furnished in copper-free aluminum (6061-T6).

Aiming: 360HD Mounting System can adjust 180° vertically and rotate 360° horizontally. 'O' Ring helps maintain fixture position. Design withstands 73 lb. static load prior to movement for optical alignment with a 1/2" pipe thread for mounting.

Light Source Detail: 12W and 20W use a Corrected Cold Phosphor Technology® module with electrical disconnects., 27W uses COB (Chip on Board) technology and modular design with electrical quick disconnects.

Optics: Interchangeable optics permit changes in the field.

Hardware: Tamper-resistant, stainless steel hardware. Hardware is black oxide treated for additional corrosion resistance.

Sealing: 'O' Ring provides water-tight seal., Anti-condensation and corrosion vent equalizes fixture pressure and eliminates potential for damage to internal components.

Finish Detail: StarGuard, our 15-stage chromate-free process, cleans and conversion coats aluminum components prior to application of Class 'A' TGIC polyester powder coating. It is RoHS compliant.

Warranty: 5-year limited warranty.

WARNING: This is a remote driver product. Please check "Mountings With A Power Supply" or "Power Supplies" to order remote driver separately. (IMPORTANT: Driver wattage MUST match selected fixture wattage. Example: 12W Light Source = 12W Driver)

DENALI - Wall Mount - Remote Driver - LED COB - Style G - Single

Finishes

STANDARD FINISHES



[BLP] Satin Black



[BZP] Satin Bronze



[WHP] Satin White



[SAP] Satin Aluminum



[BLW] Black Wrinkle



[BZW] Bronze Wrinkle



[WHW] White Wrinkle



[VER] Verde

PREMIUM FINISHES



[CMG] Cascade Mountain Granite



[SMG] Sierra Mountain Granite



[RMG] Rocky Mountain Granite



[AMG] Aleutian Mountain Granite



[TXF] Textured Forest

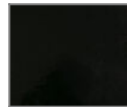

[BCM] Black Chrome

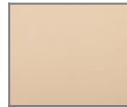

[BGE] Beige



[WCP] Weathered Copper



[OCP] Old Copper



[HUG] Hunter Green

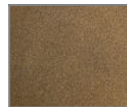

[ABP] Antique Brass Powder

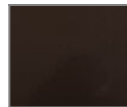

[BPP] Brown Patina Powder

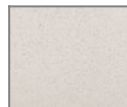

[SDS] Sonoran Desert Sandstone



[WIR] Weathered Iron



[CAP] Clear Anodized Powder



[CRM] Cream

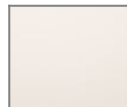

[AQW] Antique White

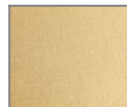

[NBP] Natural Brass Powder

OTHER - RAL



[RAL] RAL Color

OTHER - CUSTOM COLOR



[CUS] Custom Color

DENALI - Wall Mount - Remote Driver - LED COB - Style G - Single

Light Source

Light Source	Optic	Beam Angle	CCT (K)	CRI	R9	Input Power (W)	Delivered Lumens (Lm)	CBCP
x58	SP - Spot	15	2700	80	>15	12	721	3865
x58	MFL - Medium Flood	35	2700	80	>15	12	661	1493
x58	WFL - Wide Flood	60	2700	80	>15	12	623	627
x59	SP - Spot	15	3000	80	>15	12	756	4048
x59	MFL - Medium Flood	35	3000	80	>15	12	692	1564
x59	WFL - Wide Flood	60	3000	80	>15	12	653	657
x60	SP - Spot	15	4000	80	>15	12	851	4561
x60	MFL - Medium Flood	35	4000	80	>15	12	780	1762
x60	WFL - Wide Flood	60	4000	80	>15	12	736	740
x61	SP - Spot	15	2700	80	>15	20	1307	7103
x61	MFL - Medium Flood	35	2700	80	>15	20	1125	2623
x61	WFL - Wide Flood	60	2700	80	>15	20	1064	1049
x62	SP - Spot	15	3000	80	>15	20	1376	7478
x62	MFL - Medium Flood	35	3000	80	>15	20	1184	2761
x62	WFL - Wide Flood	60	3000	80	>15	20	1120	1104
x63	SP - Spot	15	4000	80	>15	20	1435	7800
x63	MFL - Medium Flood	35	4000	80	>15	20	1235	2880
x63	WFL - Wide Flood	60	4000	80	>15	20	1168	1152
x64	SP - Spot	15	2700	80	>15	27	1767	15656
x64	MFL - Medium Flood	35	2700	80	>15	27	1586	4649
x64	WFL - Wide Flood	60	2700	80	>15	27	1383	1515
x65	SP - Spot	15	3000	80	>15	27	1820	16132
x65	MFL - Medium Flood	35	3000	80	>15	27	1634	4791
x65	WFL - Wide Flood	60	3000	80	>15	27	1426	1561
x66	SP - Spot	15	4000	80	>15	27	1923	17042
x66	MFL - Medium Flood	35	4000	80	>15	27	1726	5061
x66	WFL - Wide Flood	60	4000	80	>15	27	1506	1649
x67	SP - Spot	15	2700	90	>50	27	1676	14852
x67	MFL - Medium Flood	35	2700	90	>50	27	1504	4411
x67	WFL - Wide Flood	60	2700	90	>50	27	1312	1437
x68	SP - Spot	15	3000	90	>50	27	1779	15770
x68	MFL - Medium Flood	35	3000	90	>50	27	1597	4683
x68	WFL - Wide Flood	60	3000	90	>50	27	1394	1526
x69	SP - Spot	15	3500	80	>15	27	2327	20620
x69	MFL - Medium Flood	35	3500	80	>15	27	2088	6124
x69	WFL - Wide Flood	60	3500	80	>15	27	1822	1995