

DRIVE STAR - In-grade - Line Voltage - LED High-Power - Deep Housing - Faceplate Surface Mount



Downloads

- Product Images (.zip)
- Technical Drawing (.zip)
- 2D (.dwg)
- 2D (.dxf)
- IES Files (.zip)
- BIM - Revit (.zip)
- Installation Instructions (.pdf)

Product Variant Examples

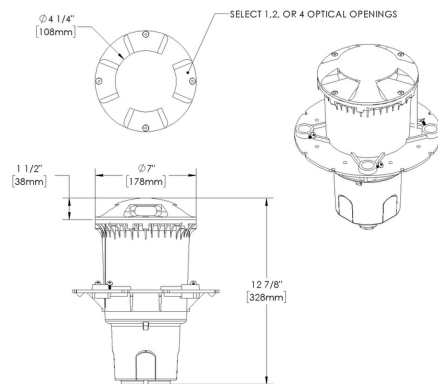

DRIVE STAR - In-grade - Line Voltage - LED High-Power - Deep Housing - Faceplate Surface Mount

Available Logic & Configurations

DR2- 01	IN- 02	LID- 03	LHP- 04	AL- 05	FSM- 06B	___- 06C	HDE- 06D
01 SERIES DR2 - DRIVE STAR 02 CATEGORY IN - In-grade 03 DRIVER LID - Line Voltage 04 LIGHT SOURCE (TYPE) LHP - LED High-Power				05 MATERIAL AL - Aluminum 06B MOUNT FSM - Faceplate Surface Mount 06C STYLE O10 - Single Optical Opening O20 - 2 Optical Openings O40 - 4 Optical Openings 06D VERSION HDE - Deep Housing			
___- 07	NON- 09	WL00- 11	___- 12	___- 13			
07 LIGHT SOURCE e57 - 2700K CRI80 - 8W e58 - 3000K CRI80 - 8W e59 - 4000K CRI80 - 8W				09 CONTROL NON - Non-dimming 11 WIRING LENGTH WL00 - Standard 12 FINISH Standard Finishes BLP, BZP, WHP, SAP, BLW, BZW, WHW, VER Premium Finishes CMG, SMG, RMG, AMG, TXF, BCM, BGE, WCP, OCP, HUG, ABP, BPP, SDS, WIR, CAP, CRM, AQW, NBP Other - RAL RAL Other - Custom Color CUS 13 OPTION GM-R - Round Grout Mask - HP2/DR2 GM-S - Square Grout Mask - HP2/DR2			

NOTE: Not all configurations may be compatible with one another. Please configure the product for specific 2D, Photometry, Downloads, Spec Sheet and Compatible mountings and power supplies.

DRIVE STAR - In-grade - Line Voltage - LED High-Power - Deep Housing - Faceplate Surface Mount

Features



Anti-condensation vent allows moisture to exit the fixture but never enter in



Lens factory adhered to fixture cap providing hermetically sealed optical compartment



Secured with flush, countersunk tamper resistant hardware



Machined solid billet faceplate provides unmatched strength and durability



Heavy wall corrosion-free composite housing for direct burial in soil or concrete



Designed and engineered for easy install



Manufactured in the USA with sustainable processes



Water-tight anti-siphon plug prevents moisture ingress from wireways



Easily replaceable modular components reduce waste and extend fixture life

Technical

Driver: Line Voltage

Light Source (Type): LED High-Power

Material: Aluminum

CCT (K): 2700, 3000, 4000

CRI: 80

Input Power (W): 8

Delivered Lumens (lm): Array

Control: Non-dimming

Mount: Faceplate Surface Mount

Style: Single Optical Opening, 2 Optical Openings, 4 Optical Openings

Version: Deep Housing

Wiring Length: Standard

Finish: Standard Finishes, Premium Finishes, Other - RAL, Other - Custom Color

Option: Round Grout Mask - HP2/DR2, Square Grout Mask - HP2/DR2

Material Detail: Furnished in copper-free aluminum (6061-T6).

Light Source Detail: High power LEDs modular design with electrical disconnects.

Hardware: Tamper-resistant, stainless steel hardware. Hardware is black oxide treated for additional corrosion resistance.

Sealing: High temperature silicone 'O' Ring at faceplate. HydroLock® technology provides fail-safe water barrier between junction box and interior components.

Finish Detail: StarGuard, our 15-stage chromate-free process, cleans and conversion coats aluminum components prior to application of Class 'A' TGIC polyester powder coating. It is RoHS compliant.

Warranty: 5-year limited warranty.

DRIVE STAR - In-grade - Line Voltage - LED High-Power - Deep Housing - Faceplate Surface Mount

Finishes

STANDARD FINISHES



[BLP] Satin Black

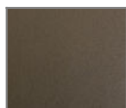

[BZP] Satin Bronze



[WHP] Satin White



[SAP] Satin Aluminum



[BLW] Black Wrinkle



[BZW] Bronze Wrinkle



[WHW] White Wrinkle



[VER] Verde

PREMIUM FINISHES

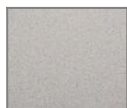

[CMG] Cascade Mountain Granite



[SMG] Sierra Mountain Granite



[RMG] Rocky Mountain Granite



[AMG] Aleutian Mountain Granite



[TXF] Textured Forest



[BCM] Black Chrome



[BGE] Beige



[WCP] Weathered Copper

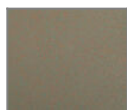

[OCP] Old Copper



[HUG] Hunter Green

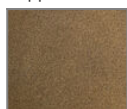

[ABP] Antique Brass Powder

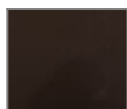

[BPP] Brown Patina Powder

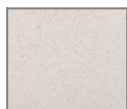

[SDS] Sonoran Desert Sandstone



[WIR] Weathered Iron



[CAP] Clear Anodized Powder



[CRM] Cream

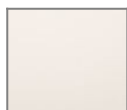

[AQW] Antique White

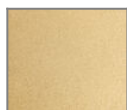

[NBP] Natural Brass Powder

OTHER - RAL



[RAL] RAL Color

OTHER - CUSTOM COLOR

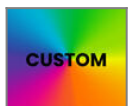

[CUS] Custom Color

DRIVE STAR - In-grade - Line Voltage - LED High-Power - Deep Housing - Faceplate Surface Mount

Light Source

Light Source	Optic	Beam Angle	CCT (K)	CRI	R9	Input Power (W)	Delivered Lumens (Lm)	CBCP
e57	-	50	2700	80	>15	8		
e58	-	50	3000	80	>15	8		
e59	-	50	4000	80	>15	8		