

# MINI MICRO - Wall Mount - Low Voltage - LED High-Power - Style L - Single - Asymmetrical Optics

UPGRADED



Downloads

- Product Images (.zip)
- Technical Drawing (.zip)
- 2D (.dwg)
- 2D (.dxf)
- IES Files (.zip)
- BIM - Revit (.zip)
- Installation Instructions (.pdf)

Product Variant Examples

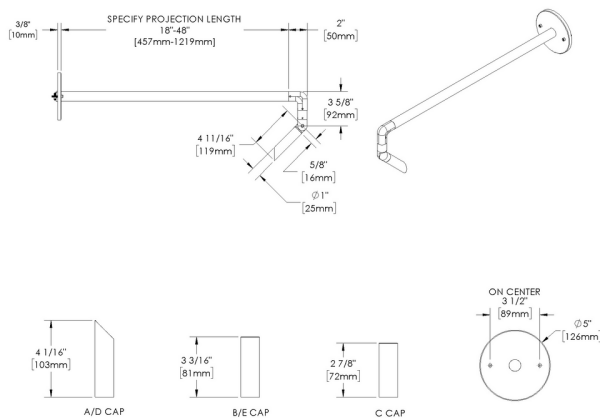

# MINI MICRO - Wall Mount - Low Voltage - LED High-Power - Style L - Single - Asymmetrical Optics

## Available Logic & Configurations

**MM-** **WM-** **LOD-** **LHP-** **AL-** **BC7-** **-** **SL-F10-OASY-** **-**  
 01 02 03 04 05 06B 06C 06D 06F

**01 SERIES**

**MM** - MINI MICRO

**02 CATEGORY**

**WM** - Wall Mount

**03 DRIVER**

**LOD** - Low Voltage

**04 LIGHT SOURCE (TYPE)**

**LHP** - LED High-Power

**05 MATERIAL**

**AL** - Aluminum

**06B MOUNT**

**BC7** - Canopy BC7

**06C STYLE**

**CA** - Cap A - 45° (With Weephole)

**CB** - Cap B - 90° (With Weephole)

**CC** - Cap C - Flush Lens

**CD** - Cap D - 45°

**CE** - Cap E - 90°

**06D VERSION**

**SL-F10-OASY** - Style L - Single - Asymmetrical Optics

**06F SIZE**

**ST18** - Stem length: 18"

**ST24** - Stem length: 24"

**ST30** - Stem length: 30"

**ST36** - Stem length: 36"

**ST42** - Stem length: 42"

**ST48** - Stem length: 48"

**-** **ASY-** **09-** **-** **-** **-**  
 07 08 10A 10B 11 12

**07 LIGHT SOURCE**

**e70** - 2700K CRI80 - 3W (151 - 151 lm)

**e71** - 3000K CRI80 - 3W (158 - 158 lm)

**e72** - 4000K CRI80 - 3W (178 - 178 lm)

**e73** - Amber - 3W

**e85** - 2700K CRI90 - 3W

**e86** - 3000K CRI90 - 3W

**e87** - 3500K CRI80 - 3W

**08 OPTIC**

**ASY** - Asymmetrical (17x31°)

**10A LENS**

**09** - Clear (Standard)

**10B SHIELDING**

**00** - Not included (Standard)

**11** - Honeycomb Baffle

**11 WIRING LENGTH**

**WL00** - Standard

**WL05** - 5 Ft Leads

**WL25** - 25 Ft Leads

**12 FINISH**

Standard Finishes

**BLP, BZP, WHP, SAP, BLW, BZW, WHW, VER**

Premium Finishes

**CMG, SMG, RMG, AMG, TXF, BCM, BGE, WCP, OCP, HUG, ABP, BPP, SDS,**

**WIR, CAP, CRM, AQW, NBP**

Other - RAL

**RAL**

Other - Custom Color

**CUS**

**NOTE:** Not all configurations may be compatible with one another. Please configure the product for specific 2D, Photometry, Downloads, Spec Sheet and Compatible mountings and power supplies.

# MINI MICRO - Wall Mount - Low Voltage - LED High-Power - Style L - Single - Asymmetrical Optics

## Features



Anti-condensation vent allows moisture to exit the fixture but never enter in



Lens factory adhered to fixture cap providing hermetically sealed optical compartment



Manufactured in the USA with sustainable processes



Aim & Lock knuckle eliminates need for re-aiming & adjustments



Water-tight anti-siphon plug prevents moisture ingress from wireways



Secured with tamper-resistant, stainless steel hardware



Easily replaceable modular components reduce waste and extend fixture life



Slip fit cap & high temp. silicone 'O' ring provides reliable water-tight seal



Solid billet fixture body provides unmatched durability and heat management



360SL knuckle provides 360° horizontal rotation and vertical adjustment

**WARNING: This is a low voltage product. Please check "Mountings With A Power Supply" or "Power Supplies" to order remote transformer separately.**

## Technical

**Driver:** Low Voltage

**Light Source (Type):** LED High-Power

**Material:** Aluminum

**CCT (K):** Amber, 2700, 3500, 3000, 4000

**CRI:** 80, 90

**Input Power (W):** 3

**Delivered Lumens (lm):** 151 - 178

**Beam Angle (°):** 17x31

**Mount:** Canopy BC7

**Style:** Cap A - 45° (With Weephole), Cap B - 90° (With Weephole), Cap C - Flush Lens, Cap D - 45°, Cap E - 90°

**Version:** Style L - Single - Asymmetrical Optics

**Size:** Stem length: 18", Stem length: 24", Stem length: 30", Stem length: 36", Stem length: 42", Stem length: 48"

**Lens:** Clear (Standard)

**Shielding:** Not included (Standard), Honeycomb Baffle

**Wiring Length:** Standard, 5 Ft Leads, 25 Ft Leads

**Finish:** Standard Finishes, Premium Finishes, Other - RAL, Other - Custom Color

**Body:** Unibody design, with enclosed, water-proof wireway and integral heat sink, fully machined from solid billet.

**Material Detail:** Furnished in copper-free aluminum (6061-T6).

**Aiming:** Knuckle enables 180° vertical adjustment. 'O' Ring helps maintain fixture position. Design withstands 73 lbs. static load prior to movement for optical alignment. Mounts with a 1/2" pipe thread.

**Light Source Detail:** High power LEDs modular design with electrical disconnects., Non-dimming.

**Optics:** Interchangeable optics permit changes in the field.

**Hardware:** Tamper-resistant, stainless steel hardware. Hardware is black oxide treated for additional corrosion resistance.

**Sealing:** 'O' Ring provides water-tight seal.

**Finish Detail:** StarGuard, our 15-stage chromate-free process, cleans and conversion coats aluminum components prior to application of Class 'A' TGIC polyester powder coating. It is RoHS compliant.

**Warranty:** 5-year limited warranty.

# MINI MICRO - Wall Mount - Low Voltage - LED High-Power - Style L - Single - Asymmetrical Optics

## Finishes

### STANDARD FINISHES



[BLP]  
Satin Black

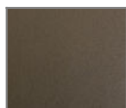

[BZP]  
Satin Bronze



[WHP]  
Satin White



[SAP]  
Satin Aluminum



[BLW]  
Black Wrinkle



[BZW]  
Bronze Wrinkle



[WHW]  
White Wrinkle



[VER]  
Verde

### PREMIUM FINISHES

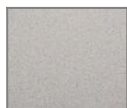

[CMG]  
Cascade Mountain Granite



[SMG]  
Sierra Mountain Granite



[RMG]  
Rocky Mountain Granite



[AMG]  
Aleutian Mountain Granite



[TXF]  
Textured Forest



[BCM]  
Black Chrome



[BGE]  
Beige



[WCP]  
Weathered Copper

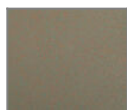

[OCP]  
Old Copper



[HUG]  
Hunter Green

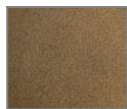

[ABP]  
Antique Brass Powder

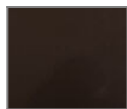

[BPP]  
Brown Patina Powder

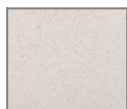

[SDS]  
Sonoran Desert Sandstone



[WIR]  
Weathered Iron



[CAP]  
Clear Anodized Powder



[CRM]  
Cream

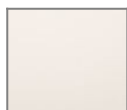

[AQW]  
Antique White

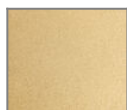

[NBP]  
Natural Brass Powder

### OTHER - RAL



[RAL]  
RAL Color

### OTHER - CUSTOM COLOR



[CUS]  
Custom Color

# MINI MICRO - Wall Mount - Low Voltage - LED High-Power - Style L - Single - Asymmetrical Optics

## Light Source

Light Source	Optic	Beam Angle	CCT (K)	CRI	R9	Input Power (W)	Delivered Lumens (Lm)	CBCP
e70	ASY - Asymmetrical	17x31	2700	80	>15	3	151	613
e71	ASY - Asymmetrical	17x31	3000	80	>15	3	158	642
e72	ASY - Asymmetrical	17x31	4000	80	>15	3	178	721
e73	ASY - Asymmetrical	17x31	Amber			3		
e85	ASY - Asymmetrical	17x31	2700	90	>50	3		
e86	ASY - Asymmetrical	17x31	3000	90	>50	3		
e87	ASY - Asymmetrical	17x31	3500	80	>15	3		