

MICRO NITE - Wall Mount - Low Voltage - LED High-Power - Style L - Single



Downloads

- Product Images (.zip)
- Technical Drawing (.zip)
- 2D (.dwg)
- 2D (.dxf)
- IES Files (.zip)
- BIM - Revit (.zip)
- Installation Instructions (.pdf)

Product Variant Examples

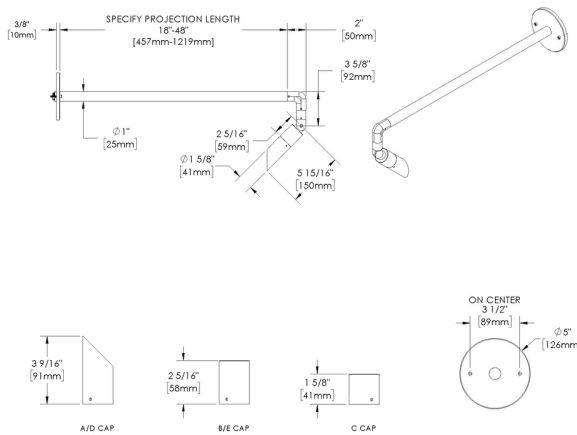

MICRO NITE - Wall Mount - Low Voltage - LED High-Power - Style L - Single

Available Logic & Configurations

MN- 01 **WM-** 02 **LOD-** 03 **LHP-** 04 **AL-** 05 **BC-** 06B **-** 06C **SL-F10-** 06D **-** 06F

01 SERIES

MN - MICRO NITE

02 CATEGORY

WM - Wall Mount

03 DRIVER

LOD - Low Voltage

04 LIGHT SOURCE (TYPE)

LHP - LED High-Power

05 MATERIAL

AL - Aluminum

06B MOUNT

BC - Canopy

06C STYLE

CA - Cap A - 45° (With Weephole)

CB - Cap B - 90° (With Weephole)

CC - Cap C - Flush Lens

CD - Cap D - 45°

CE - Cap E - 90°

06D VERSION

SL-F10 - Style L - Single

06F SIZE

ST18 - Stem length: 18"

ST24 - Stem length: 24"

ST30 - Stem length: 30"

ST36 - Stem length: 36"

ST42 - Stem length: 42"

ST48 - Stem length: 48"

- 07 **-** 08 **-** 10A **-** 10B **-** 11 **-** 12

07 LIGHT SOURCE

e67 - 2700K CRI80 - 7W (435 - 459 lm)

e68 - 3000K CRI80 - 7W (464 - 489 lm)

e69 - 4000K CRI80 - 7W (478 - 504 lm)

e75 - Amber - 7W

e82 - 2700K CRI90 - 7W

e83 - 3000K CRI90 - 7W

e84 - 3500K CRI80 - 7W

08 OPTIC

SP - Spot (17°)

NFL - Narrow Flood (25°)

MFL - Medium Flood (30°)

10A LENS

12 - Soft Focus

13 - Rectilinear

10B SHIELDING

00 - Not included (Standard)

11 - Honeycomb Baffle

11 WIRING LENGTH

WL00 - Standard

WL05 - 5 Ft Leads

WL25 - 25 Ft Leads

12 FINISH

Standard Finishes

BLP, BZP, WHP, SAP, BLW, BZW, WHW, VER

Premium Finishes

CMG, SMG, RMG, AMG, TXF, BCM, BGE, WCP, OCP, HUG, ABP, BPP, SDS,

WIR, CAP, CRM, AQW, NBP

Other - RAL

RAL

Other - Custom Color

CUS

NOTE: Not all configurations may be compatible with one another. Please configure the product for specific 2D, Photometry, Downloads, Spec Sheet and Compatible mountings and power supplies.

MICRO NITE - Wall Mount - Low Voltage - LED High-Power - Style L - Single

Features



Anti-condensation vent allows moisture to exit the fixture but never enter in



Lens factory adhered to fixture cap providing hermetically sealed optical compartment



Manufactured in the USA with sustainable processes



Aim & Lock knuckle eliminates need for re-aiming & adjustments



Water-tight anti-siphon plug prevents moisture ingress from wireways



Secured with tamper-resistant, stainless steel hardware



Easily replaceable modular components reduce waste and extend fixture life



Slip fit cap & high temp. silicone 'O' ring provides reliable water-tight seal



Solid billet fixture body provides unmatched durability and heat management



360SL knuckle provides 360° horizontal rotation and vertical adjustment

WARNING: This is a low voltage product. Please check "Mountings With A Power Supply" or "Power Supplies" to order remote transformer separately.

Technical

Driver: Low Voltage

Light Source (Type): LED High-Power

Material: Aluminum

CCT (K): Amber, 2700, 3500, 3000, 4000

CRI: 80, 90

Input Power (W): 7

Delivered Lumens (lm): 435 - 504

Beam Angle (°): 17, 25, 30

Mount: Canopy

Style: Cap A - 45° (With Weephole), Cap B - 90° (With Weephole), Cap C - Flush Lens, Cap D - 45°, Cap E - 90°

Version: Style L - Single

Size: Stem length: 18", Stem length: 24", Stem length: 30", Stem length: 36", Stem length: 42", Stem length: 48"

Lens: Soft Focus, Rectilinear

Shielding: Not included (Standard), Honeycomb Baffle

Wiring Length: Standard, 5 Ft Leads, 25 Ft Leads

Finish: Standard Finishes, Premium Finishes, Other - RAL, Other - Custom Color

Body: Unibody design, with enclosed, water-proof wireway and integral heat sink, fully machined from solid billet.

Material Detail: Furnished in copper-free aluminum (6061-T6).

Aiming: Knuckle enables 180° vertical adjustment. 'O' Ring helps maintain fixture position. Design withstands 73 lbs. static load prior to movement for optical alignment. Mounts with a 1/2" pipe thread.

Light Source Detail: High power LEDs modular design with electrical disconnects.

Optics: Interchangeable optics permit changes in the field.

Hardware: Tamper-resistant, stainless steel hardware. Hardware is black oxide treated for additional corrosion resistance.

Sealing: 'O' Ring provides water-tight seal.

Finish Detail: StarGuard, our 15-stage chromate-free process, cleans and conversion coats aluminum components prior to application of Class 'A' TGIC polyester powder coating. It is RoHS compliant.

Warranty: 5-year limited warranty.

MICRO NITE - Wall Mount - Low Voltage - LED High-Power - Style L - Single

Finishes

STANDARD FINISHES



[BLP] Satin Black

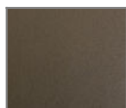

[BZP] Satin Bronze



[WHP] Satin White



[SAP] Satin Aluminum



[BLW] Black Wrinkle



[BZW] Bronze Wrinkle



[WHW] White Wrinkle



[VER] Verde

PREMIUM FINISHES

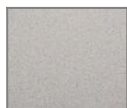

[CMG] Cascade Mountain Granite



[SMG] Sierra Mountain Granite



[RMG] Rocky Mountain Granite



[AMG] Aleutian Mountain Granite



[TXF] Textured Forest



[BCM] Black Chrome



[BGE] Beige



[WCP] Weathered Copper

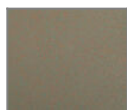

[OCP] Old Copper



[HUG] Hunter Green

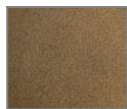

[ABP] Antique Brass Powder

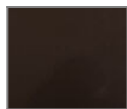

[BPP] Brown Patina Powder

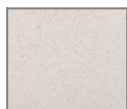

[SDS] Sonoran Desert Sandstone



[WIR] Weathered Iron



[CAP] Clear Anodized Powder



[CRM] Cream

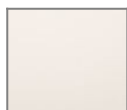

[AQW] Antique White

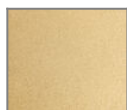

[NBP] Natural Brass Powder

OTHER - RAL



[RAL] RAL Color

OTHER - CUSTOM COLOR

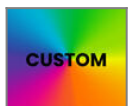

[CUS] Custom Color

MICRO NITE - Wall Mount - Low Voltage - LED High-Power - Style L - Single

Light Source

| Light Source | Optic | Beam Angle | CCT (K) | CRI | R9 | Input Power (W) | Delivered Lumens (Lm) | CBCP |
|--------------|--------------------|------------|---------|-----|-----|-----------------|-----------------------|------|
| e67 | SP - Spot | 17 | 2700 | 80 | >15 | 7 | 459 | 3632 |
| e67 | NFL - Narrow Flood | 25 | 2700 | 80 | >15 | 7 | 435 | 1708 |
| e67 | MFL - Medium Flood | 30 | 2700 | 80 | >15 | 7 | 438 | 1337 |
| e68 | SP - Spot | 17 | 3000 | 80 | >15 | 7 | 489 | 3871 |
| e68 | NFL - Narrow Flood | 25 | 3000 | 80 | >15 | 7 | 464 | 1821 |
| e68 | MFL - Medium Flood | 30 | 3000 | 80 | >15 | 7 | 467 | 1425 |
| e69 | SP - Spot | 17 | 4000 | 80 | >15 | 7 | 504 | 3991 |
| e69 | NFL - Narrow Flood | 25 | 4000 | 80 | >15 | 7 | 478 | 1877 |
| e69 | MFL - Medium Flood | 30 | 4000 | 80 | >15 | 7 | 481 | 1469 |
| e75 | SP - Spot | 17 | | | | 7 | | |
| e75 | NFL - Narrow Flood | 25 | | | | 7 | | |
| e75 | MFL - Medium Flood | 30 | Amber | | | 7 | | |
| e82 | SP - Spot | 17 | 2700 | 90 | >50 | 7 | | |
| e82 | NFL - Narrow Flood | 25 | 2700 | 90 | >50 | 7 | | |
| e82 | MFL - Medium Flood | 30 | 2700 | 90 | >50 | 7 | | |
| e83 | SP - Spot | 17 | 3000 | 90 | >50 | 7 | | |
| e83 | NFL - Narrow Flood | 25 | 3000 | 90 | >50 | 7 | | |
| e83 | MFL - Medium Flood | 30 | 3000 | 90 | >50 | 7 | | |
| e84 | SP - Spot | 17 | 3500 | 80 | >15 | 7 | | |
| e84 | NFL - Narrow Flood | 25 | 3500 | 80 | >15 | 7 | | |
| e84 | MFL - Medium Flood | 30 | 3500 | 80 | >15 | 7 | | |