

MICRO NITE - Wall Mount - Line Voltage Via Transformer - LED High-Power - Style B - 2 Fixtures - Universal Power Module PM1



Downloads

- Product Images (.zip)
- Technical Drawing (.dwg)
- 2D (.dwg)
- 2D (.dxf)
- IES Files (.zip)
- Installation Instructions (.pdf)

Product Variant Examples

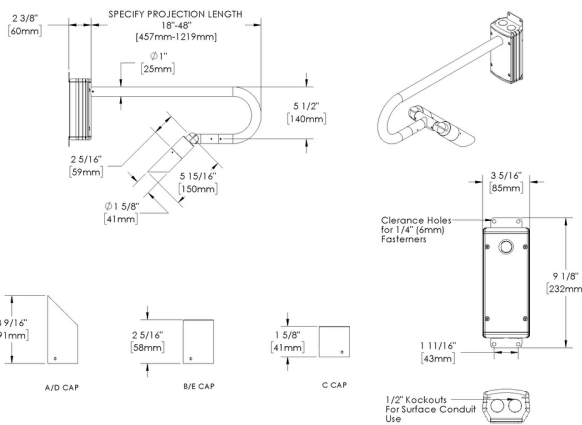

MICRO NITE - Wall Mount - Line Voltage Via Transformer - LED High-Power - Style B - 2 Fixtures - Universal Power Module PM1

Available Logic & Configurations

MN- 01 **WM-** 02 **LIT-** 03 **LHP-** 04 **AL-** 05 **PM1-** 06B **-** 06C **SB-F20-** 06D **-** 06F

01 SERIES

MN - MICRO NITE

02 CATEGORY

WM - Wall Mount

03 DRIVER

LIT - Line Voltage Via Transformer

04 LIGHT SOURCE (TYPE)

LHP - LED High-Power

05 MATERIAL

AL - Aluminum

06B MOUNT

PM1 - Universal Power Module PM1

06C STYLE

CA - Cap A - 45° (With Weephole)

CB - Cap B - 90° (With Weephole)

CC - Cap C - Flush Lens

CD - Cap D - 45°

CE - Cap E - 90°

06D VERSION

SB-F20 - Style B - 2 Fixtures

06F SIZE

ST18 - Stem length: 18"

ST24 - Stem length: 24"

ST30 - Stem length: 30"

ST36 - Stem length: 36"

ST42 - Stem length: 42"

ST48 - Stem length: 48"

- 07 **-** 08 **NON-** 09 **-** 10A **-** 10B **WL00-** 11 **-** 12 **-** 13

07 LIGHT SOURCE

e67 - 2700K CRI80 - 7W (435 - 459 lm)

e68 - 3000K CRI80 - 7W (464 - 489 lm)

e69 - 4000K CRI80 - 7W (478 - 504 lm)

e75 - Amber - 7W

e82 - 2700K CRI90 - 7W

e83 - 3000K CRI90 - 7W

e84 - 3500K CRI80 - 7W

08 OPTIC

SP - Spot (17°)

NFL - Narrow Flood (25°)

MFL - Medium Flood (30°)

09 CONTROL

NON - Non-dimming

10A LENS

12 - Soft Focus

13 - Rectilinear

10B SHIELDING

00 - Not included (Standard)

11 - Honeycomb Baffle

11 WIRING LENGTH

WL00 - Standard

12 FINISH

Standard Finishes

BLP, BZP, WHP, SAP, BLW, BZW, WHW, VER

Premium Finishes

CMG, SMG, RMG, AMG, TXF, BCM, BGE, WCP, OCP, HUG, ABP, BPP, SDS,

WIR, CAP, CRM, AQW, NBP

Other - RAL

RAL

Other - Custom Color

CUS

13 OPTION

CR - Camlock Mount - Round

CR-MB - Camlock Mount - Round - With Mounting Bracket

CT - Camlock Mount - Rectangular

CT-MB - Camlock Mount - Rectangular - With Mounting Bracket

SM - Surface Mount

NOTE: Not all configurations may be compatible with one another. Please configure the product for specific 2D, Photometry, Downloads, Spec Sheet and Compatible mountings and power supplies.

MICRO NITE - Wall Mount - Line Voltage Via Transformer - LED High-Power - Style B - 2 Fixtures - Universal Power Module PM1

Features



Anti-condensation vent allows moisture to exit the fixture but never enter in



Manufactured in the USA with sustainable processes



Aim & Lock knuckle eliminates need for re-aiming & adjustments



Water-tight anti-siphon plug prevents moisture ingress from wireways



Secured with tamper-resistant, stainless steel hardware



Easily replaceable modular components reduce waste and extend fixture life



Slip fit cap & high temp. silicone 'O' ring provides reliable water-tight seal



Solid billet fixture body provides unmatched durability and heat management



360SL knuckle provides 360° horizontal rotation and vertical adjustment

Technical

Driver: Line Voltage Via Transformer

Light Source (Type): LED High-Power

Material: Aluminum

CCT (K): Amber, 2700, 3500, 3000, 4000

CRI: 80, 90

Input Power (W): 7

Delivered Lumens (lm): 435 - 504

Beam Angle (°): 17, 25, 30

Control: Non-dimming

Mount: Universal Power Module PM1

Style: Cap A - 45° (With Weephole), Cap B - 90° (With Weephole), Cap C - Flush Lens, Cap D - 45°, Cap E - 90°

Version: Style B - 2 Fixtures

Size: Stem length: 18", Stem length: 24", Stem length: 30", Stem length: 36", Stem length: 42", Stem length: 48"

Lens: Soft Focus, Rectilinear

Shielding: Not included (Standard), Honeycomb Baffle

Wiring Length: Standard

Finish: Standard Finishes, Premium Finishes, Other - RAL, Other - Custom Color

Option: Camlock Mount - Round, Camlock Mount - Round - With Mounting Bracket, Camlock Mount - Rectangular, Camlock Mount - Rectangular - With Mounting Bracket, Surface Mount

Body: Unibody design, with enclosed, water-proof wireway and integral heat sink, fully machined from solid billet.

Material Detail: Furnished in copper-free aluminum (6061-T6).

Aiming: 360SL provides biaxial source control with 360° horizontal rotation in addition to vertical adjustment.

Light Source Detail: High power LEDs modular design with electrical disconnects.

Optics: Interchangeable optics permit changes in the field.

Hardware: Tamper-resistant, stainless steel hardware. Hardware is black oxide treated for additional corrosion resistance.

Sealing: 'O' Ring provides water-tight seal.

Note: Transformer included.

Finish Detail: StarGuard, our 15-stage chromate-free process, cleans and conversion coats aluminum components prior to application of Class 'A' TGIC polyester powder coating. It is RoHS compliant.

Warranty: 5-year limited warranty.















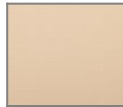

MICRO NITE - Wall Mount - Line Voltage Via Transformer - LED High-Power - Style B - 2 Fixtures - Universal Power Module PM1

Finishes

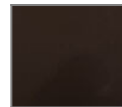
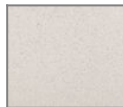
STANDARD FINISHES

 [BLP] Satin Black	 [BZP] Satin Bronze	 [WHP] Satin White
 [SAP] Satin Aluminum	 [BLW] Black Wrinkle	 [BZW] Bronze Wrinkle
 [WHW] White Wrinkle	 [VER] Verde	

PREMIUM FINISHES

 [CMG] Cascade Mountain Granite	 [SMG] Sierra Mountain Granite	 [RMG] Rocky Mountain Granite
 [AMG] Aleutian Mountain Granite	 [TXF] Textured Forest	 [BCM] Black Chrome
 [BGE] Beige	 [WCP] Weathered Copper	 [OCP] Old Copper
 [HUG] Hunter Green	 [ABP] Antique Brass Powder	 [BPP] Brown Patina Powder
 [SDS] Sonoran Desert Sandstone	 [WIR] Weathered Iron	 [CAP] Clear Anodized Powder
 [CRM] Cream	 [AQW] Antique White	 [NBP] Natural Brass Powder

OTHER - RAL



[RAL]
RAL Color

OTHER - CUSTOM COLOR

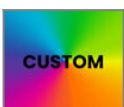

[CUS]
Custom Color

MICRO NITE - Wall Mount - Line Voltage Via Transformer - LED High-Power - Style B - 2 Fixtures - Universal Power Module PM1

Light Source

Light Source	Optic	Beam Angle	CCT (K)	CRI	R9	Input Power (W)	Delivered Lumens (Lm)	CBCP
e67	SP - Spot	17	2700	80	>15	7	459	3632
e67	NFL - Narrow Flood	25	2700	80	>15	7	435	1708
e67	MFL - Medium Flood	30	2700	80	>15	7	438	1337
e68	SP - Spot	17	3000	80	>15	7	489	3871
e68	NFL - Narrow Flood	25	3000	80	>15	7	464	1821
e68	MFL - Medium Flood	30	3000	80	>15	7	467	1425
e69	SP - Spot	17	4000	80	>15	7	504	3991
e69	NFL - Narrow Flood	25	4000	80	>15	7	478	1877
e69	MFL - Medium Flood	30	4000	80	>15	7	481	1469
e75	SP - Spot	17				7		
e75	NFL - Narrow Flood	25				7		
e75	MFL - Medium Flood	30	Amber			7		
e82	SP - Spot	17	2700	90	>50	7		
e82	NFL - Narrow Flood	25	2700	90	>50	7		
e82	MFL - Medium Flood	30	2700	90	>50	7		
e83	SP - Spot	17	3000	90	>50	7		
e83	NFL - Narrow Flood	25	3000	90	>50	7		
e83	MFL - Medium Flood	30	3000	90	>50	7		
e84	SP - Spot	17	3500	80	>15	7		
e84	NFL - Narrow Flood	25	3500	80	>15	7		
e84	MFL - Medium Flood	30	3500	80	>15	7		