

NITE STAR - Bollard - Low Voltage - Lamp MR16 Gu5.3 - Style C - Single - Anchor Base



IP66

Downloads

- Product Images (.zip)
- Technical Drawing (.zip)
- 2D (.dwg)
- 2D (.dxf)
- IES Files (.zip)
- BIM - Revit (.zip)
- Installation Instructions (.pdf)

Product Variant Examples

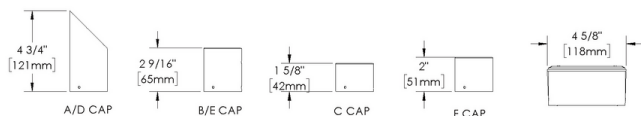
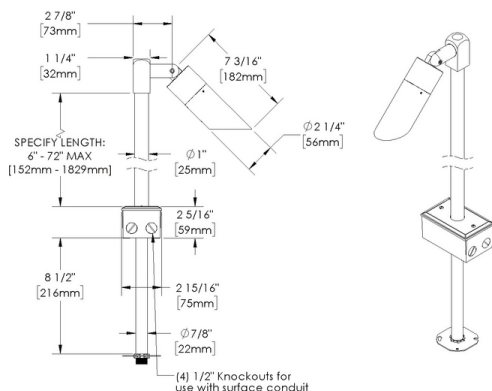

NITE STAR - Bollard - Low Voltage - Lamp MR16 Gu5.3 - Style C - Single - Anchor Base

Available Logic & Configurations

NS- 01 **BO-** 02 **LOD-** 03 **LAM16-** 04 **AL-** 05 **RO-** 06A **AB-** 06B **___-** 06C **SC-F10-** 06D **___-** 06F

- 01 SERIES**
NS - NITE STAR
- 02 CATEGORY**
BO - Bollard
- 03 DRIVER**
LOD - Low Voltage
- 04 LIGHT SOURCE (TYPE)**
LAM16 - Lamp MR16 Gu5.3

- 05 MATERIAL**
AL - Aluminum
- 06A SHAPE**
RO - Round
- 06B MOUNT**
AB - Anchor Base
- 06C STYLE**
CA - Cap A - 45° (With Weephole)
CB - Cap B - 90° (With Weephole)
CC - Cap C - Flush Lens
CD - Cap D - 45°
CE - Cap E - 90°
CF - Cap F - Extended Flush Lens
- 06D VERSION**
SC-F10 - Style C - Single
- 06F SIZE**
H24 - Height: 24"
H30 - Height: 30"
H36 - Height: 36"
H42 - Height: 42"
H48 - Height: 48"
H54 - Height: 54"
H60 - Height: 60"
H66 - Height: 66"
H72 - Height: 72"

___- 07 **___-** 10A **___-** 10B **WL00-** 11 **___-** 12

- 07 LIGHT SOURCE**
00 - Not included
359 - 2700K CRI90 - 7.5W - 10°
361 - 2700K CRI90 - 7.5W - 25°
362 - 2700K CRI90 - 7.5W - 36°
363 - 3000K CRI90 - 7.5W - 10°
365 - 3000K CRI90 - 7.5W - 25°
366 - 3000K CRI90 - 7.5W - 36°

- 10A LENS**
09 - Clear (Standard)
12 - Soft Focus
13 - Rectilinear
- 10B SHIELDING**
00 - Not included (Standard)
11 - Honeycomb Baffle
- 11 WIRING LENGTH**
WL00 - Standard
- 12 FINISH**
Standard Finishes
BLP, BZP, WHP, SAP, BLW, BZW, WHW, VER
Premium Finishes
CMG, SMG, RMG, AMG, TXF, BCM, BGE, WCP, OCP, HUG, ABP, BPP, SDS,
WIR, CAP, CRM, AQW, NBP
Other - RAL
RAL
Other - Custom Color
CUS

NOTE: Not all configurations may be compatible with one another. Please configure the product for specific 2D, Photometry, Downloads, Spec Sheet and Compatible mountings and power supplies.

NITE STAR - Bollard - Low Voltage - Lamp MR16 Gu5.3 - Style C - Single - Anchor Base

Features



Anti-condensation vent allows moisture to exit the fixture but never enter in



Lens factory adhered to fixture cap providing hermetically sealed optical compartment



Manufactured in the USA with sustainable processes



Aim & Lock knuckle eliminates need for re-aiming & adjustments



Water-tight anti-siphon plug prevents moisture ingress from wireways



Secured with tamper-resistant, stainless steel hardware



Easily replaceable modular components reduce waste and extend fixture life



Slip fit cap & high temp. silicone 'O' ring provides reliable water-tight seal



Solid billet fixture body provides unmatched durability and heat management



360SL knuckle provides 360° horizontal rotation and vertical adjustment

WARNING: This is a low voltage product. Please check "Mountings With A Power Supply" or "Power Supplies" to order remote transformer separately.

Technical

Driver: Low Voltage

Light Source (Type): Lamp MR16 Gu5.3

Material: Aluminum

CCT (K): 2700, 3000

CRI: 90

Delivered Lumens (lm): 620 - 656

Beam Angle (°): 10, 25, 36

Shape: Round

Mount: Anchor Base

Style: Cap A - 45° (With Weephole), Cap B - 90° (With Weephole), Cap C - Flush Lens, Cap D - 45°, Cap E - 90°, Cap F - Extended Flush Lens

Version: Style C - Single

Size: Height: 24", Height: 30", Height: 36", Height: 42", Height: 48", Height: 54", Height: 60", Height: 66", Height: 72"

Lens: Soft Focus, Clear (Standard), Rectilinear

Shielding: Not included (Standard), Honeycomb Baffle

Wiring Length: Standard

Finish: Standard Finishes, Premium Finishes, Other - RAL, Other - Custom Color

Body: Unibody design, with enclosed, water-proof wireway and integral heat sink, fully machined from solid billet.

Material Detail: Furnished in copper-free aluminum (6061-T6).

Aiming: Knuckle enables 180° vertical adjustment. 'O' Ring helps maintain fixture position. Design withstands 73 lbs. static load prior to movement for optical alignment. Mounts with a 1/2" pipe thread.

Light Source Detail: SORAA® LED lamp provided with fixture. Fixture does NOT include lamp if "00 - Not included" is selected for "07 - Light Source". Halogen lamp compatible. NOT for use with traditional Halogen IR technology lamps.

Hardware: Tamper-resistant, stainless steel hardware. Hardware is black oxide treated for additional corrosion resistance.

Sealing: 'O' Ring provides water-tight seal.

Finish Detail: StarGuard, our 15-stage chromate-free process, cleans and conversion coats aluminum components prior to application of Class 'A' TGIC polyester powder coating. It is RoHS compliant.

Warranty: 5-year limited warranty.

NITE STAR - Bollard - Low Voltage - Lamp MR16 Gu5.3 - Style C - Single - Anchor Base

Finishes

STANDARD FINISHES



[BLP] Satin Black



[BZP] Satin Bronze



[WHP] Satin White

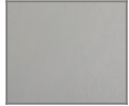

[SAP] Satin Aluminum



[BLW] Black Wrinkle



[BZW] Bronze Wrinkle



[WHW] White Wrinkle



[VER] Verde

PREMIUM FINISHES



[CMG] Cascade Mountain Granite



[SMG] Sierra Mountain Granite



[RMG] Rocky Mountain Granite



[AMG] Aleutian Mountain Granite



[TXF] Textured Forest

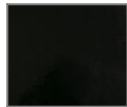

[BCM] Black Chrome

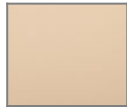

[BGE] Beige



[WCP] Weathered Copper



[OCP] Old Copper



[HUG] Hunter Green



[ABP] Antique Brass Powder



[BPP] Brown Patina Powder

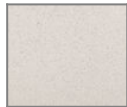

[SDS] Sonoran Desert Sandstone



[WIR] Weathered Iron



[CAP] Clear Anodized Powder



[CRM] Cream

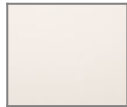

[AQW] Antique White



[NBP] Natural Brass Powder

OTHER - RAL



[RAL] RAL Color

OTHER - CUSTOM COLOR



[CUS] Custom Color

NITE STAR - Bollard - Low Voltage - Lamp MR16 Gu5.3 - Style C - Single - Anchor Base

Light Source

Light Source	Optic	Beam Angle	CCT (K)	CRI	R9	Input Power (W)	Delivered Lumens (Lm)	CBCP
359	NSP - Narrow Spot	10	2700	90	>50	7.5	620	8000
361	NFL - Narrow Flood	25	2700	90	>50	7.5	640	3170
362	MFL - Medium Flood	36	2700	90	>50	7.5	647	1550
363	NSP - Narrow Spot	10	3000	90	>50	7.5	636	8400
365	NFL - Narrow Flood	25	3000	90	>50	7.5	655	3300
366	MFL - Medium Flood	36	3000	90	>50	7.5	656	1650