

# STEP STAR - Wall Recessed - Low Voltage - Lamp MR16 Gu5.3 - Square - Junction Box - Faceplate: Louvered - Pattern D



**Downloads**

- Product Images (.zip)
- Technical Drawing (.zip)
- 2D (.dwg)
- 2D (.dxf)
- BIM - Revit (.zip)
- Installation Instructions (.pdf)

**Product Variant Examples**

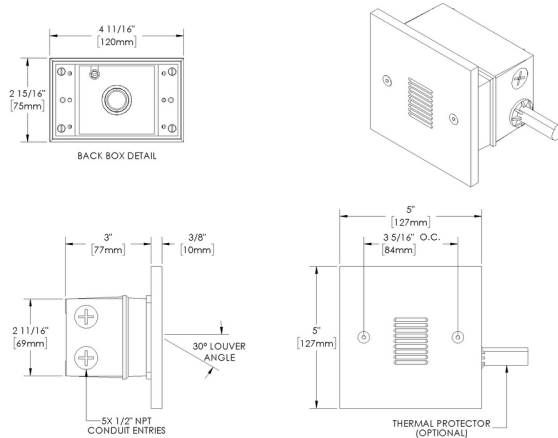

# STEP STAR - Wall Recessed - Low Voltage - Lamp MR16 Gu5.3 - Square - Junction Box - Faceplate: Louvered - Pattern D

## Available Logic & Configurations

**SS-** **WR-** **LOD-** **LAM16-** **\_\_\_-** **SQ-** **JB-** **FLDD-**  
01 02 03 04 05 06A 06B 06C

**01 SERIES**

**SS** - STEP STAR

**02 CATEGORY**

**WR** - Wall Recessed

**03 DRIVER**

**LOD** - Low Voltage

**04 LIGHT SOURCE (TYPE)**

**LAM16** - Lamp MR16 Gu5.3

**05 MATERIAL**

**AL** - Aluminum

**BR** - Brass

**SS** - Stainless Steel

**06A SHAPE**

**SQ** - Square

**06B MOUNT**

**JB** - Junction Box

**06C STYLE**

**FLDD** - Faceplate: Louvered - Pattern D - 30° Angle - Rectangular

**\_\_\_-** **13-** **00-** **WL00-** **\_\_\_-**  
07 10A 10B 11 12

**07 LIGHT SOURCE**

**00** - Not included

**359** - 2700K CRI90 - 7.5W - 10°

**361** - 2700K CRI90 - 7.5W - 25°

**362** - 2700K CRI90 - 7.5W - 36°

**363** - 3000K CRI90 - 7.5W - 10°

**365** - 3000K CRI90 - 7.5W - 25°

**366** - 3000K CRI90 - 7.5W - 36°

**10A LENS**

**13** - Rectilinear

**10B SHIELDING**

**00** - Not included (Standard)

**11 WIRING LENGTH**

**WL00** - Standard

**12 FINISH**

Standard Finishes

**BLP, BZP, WHP, SAP, BLW, BZW, WHW, VER**

Premium Finishes

**CMG, SMG, RMG, AMG, TXF, BCM, BGE, WCP, OCP, HUG, ABP, BPP, SDS,**

**WIR, CAP, CRM, AQW, NBP**

Other - RAL

**RAL**

Other - Custom Color

**CUS**

Brass Finishes

**MAB, POB, MIT**

Stainless Steel Finishes

**MAS, POS**

**NOTE:** Not all configurations may be compatible with one another. Please configure the product for specific 2D, Photometry, Downloads, Spec Sheet and Compatible mountings and power supplies.

# STEP STAR - Wall Recessed - Low Voltage - Lamp MR16 Gu5.3 - Square - Junction Box - Faceplate: Louvered - Pattern D

## Features



Lens factory adhered to fixture cap providing hermetically sealed optical compartment



Secured with flush, countersunk tamper resistant hardware



Machined solid billet faceplate provides unmatched strength and durability



Manufactured in the USA with sustainable processes



Water-tight anti-siphon plug prevents moisture ingress from wireways



Easily replaceable modular components reduce waste and extend fixture life

**WARNING: This is a low voltage product. Please check "Mountings With A Power Supply" or "Power Supplies" to order remote transformer separately.**

## Technical

**Driver:** Low Voltage

**Light Source (Type):** Lamp MR16 Gu5.3

**Material:** Aluminum, Brass, Stainless Steel

**CCT (K):** 2700, 3000

**CRI:** 90

**Delivered Lumens (lm):** Array

**Beam Angle (°):** 10, 25, 36

**Shape:** Square

**Mount:** Junction Box

**Style:** Faceplate: Louvered - Pattern D - 30° Angle - Rectangular

**Lens:** Rectilinear

**Shielding:** Not included (Standard)

**Wiring Length:** Standard

**Finish:** Standard Finishes, Premium Finishes, Other - RAL, Other - Custom Color, Brass Finishes, Stainless Steel Finishes

**Material Detail:** Furnished in brass (360)., Furnished in copper-free aluminum (6061-T6).

**Aiming:** Adjustable lamp bracket with up to 24° vertical aiming, captive thumb screw and quick release bracket to maintain optical alignment during re-lamping.

**Light Source Detail:** SORAA® LED lamp provided with fixture. Fixture does NOT include lamp if "00 - Not included" is selected for "07 - Light Source". Halogen lamp compatible. NOT for use with traditional Halogen IR technology lamps.

**Hardware:** Tamper-resistant, stainless steel hardware. Hardware is black oxide treated for additional corrosion resistance.

**Sealing:** 'O' Ring provides water-tight seal., 1/8" thick HT-805A silicone foam gasket with acrylic adhesive for water-tight seal.

**Finish Detail:** Powder coat or metal finish options available for brass material., Metal finish option only for stainless steel material., StarGuard, our 15-stage chromate-free process, cleans and conversion coats aluminum components prior to application of Class 'A' TGIC polyester powder coating. It is RoHS compliant.

**Warranty:** 5-year limited warranty.

# STEP STAR - Wall Recessed - Low Voltage - Lamp MR16 Gu5.3 - Square - Junction Box - Faceplate: Louvered - Pattern D

## Finishes

### STANDARD FINISHES

 [BLP] Satin Black	 [BZP] Satin Bronze	 [WHP] Satin White
 [SAP] Satin Aluminum	 [BLW] Black Wrinkle	 [BZW] Bronze Wrinkle
 [WHW] White Wrinkle	 [VER] Verde	

### PREMIUM FINISHES

 [CMG] Cascade Mountain Granite	 [SMG] Sierra Mountain Granite	 [RMG] Rocky Mountain Granite
 [AMG] Aleutian Mountain Granite	 [TXF] Textured Forest	 [BCM] Black Chrome
 [BGE] Beige	 [WCP] Weathered Copper	 [OCP] Old Copper
 [HUG] Hunter Green	 [ABP] Antique Brass Powder	 [BPP] Brown Patina Powder
 [SDS] Sonoran Desert Sandstone	 [WIR] Weathered Iron	 [CAP] Clear Anodized Powder
 [CRM] Cream	 [AQW] Antique White	 [NBP] Natural Brass Powder

### OTHER - RAL



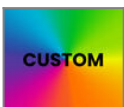

[RAL]  
RAL Color

### OTHER - CUSTOM COLOR





[CUS]  
Custom Color

### BRASS FINISHES

 [MAB] Machined	 [POB] Polished	 [MIT] Mitique
--	--	--

### STAINLESS STEEL FINISHES

 [MAS] Machined	 [POS] Polished
--	--

# STEP STAR - Wall Recessed - Low Voltage - Lamp MR16 Gu5.3 - Square - Junction Box - Faceplate: Louvered - Pattern D

(Brass)

(Brass)

(Stainless  
Steel)

(Stainless  
Steel)

# STEP STAR - Wall Recessed - Low Voltage - Lamp MR16 Gu5.3 - Square - Junction Box - Faceplate: Louvered - Pattern D

## Light Source

Light Source	Optic	Beam Angle	CCT (K)	CRI	R9	Input Power (W)	Delivered Lumens (Lm)	CBCP
359	NSP - Narrow Spot	10	2700	90	>50	7.5		8000
361	NFL - Narrow Flood	25	2700	90	>50	7.5		3170
362	MFL - Medium Flood	36	2700	90	>50	7.5		1550
363	NSP - Narrow Spot	10	3000	90	>50	7.5		8400
365	NFL - Narrow Flood	25	3000	90	>50	7.5		3300
366	MFL - Medium Flood	36	3000	90	>50	7.5		1650