

# In-grade HP2 - Round Grout Mask - Remote Driver - Brass

Date Project Type

IP68



IP68

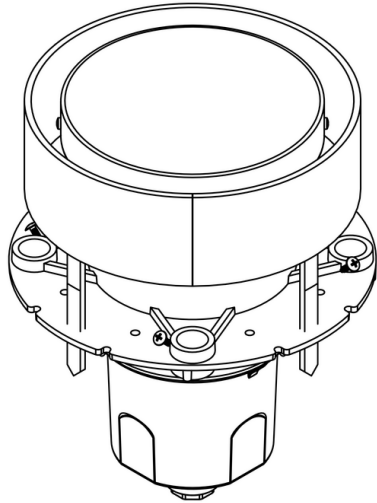

[Downloads](#)

[Product Image](#)

# In-grade HP2 - Round Grout Mask - Remote Driver - Brass

Date  Project  Type

## Configure

**HP2 -**      **RG -**      **DR-RM -**      **BR -**      **\_\_\_ -**      **\_\_\_ -**  
 01            02            03            04            05            06

In-grade HP2 - Round Grout Mask - Remote Driver - Brass

### 01 ACCESSORIES

**HP2** - In-grade HP2

### 02 MOUNT

**RG** - Round Grout Mask

### 03 VERSION

**DR-RM** - Remote Driver

### 04 MATERIAL

**BR** - Brass

### 05 POWER SUPPLY

**LCB-10W-MT-010** - LCB - 10W - 120V,277V - 0-10V

**LCB-12W-MT-010** - LCB - 12W - 120V,277V - 0-10V

**LCB-20W-MT-010** - LCB - 20W - 120V,277V - 0-10V

**LCB-23W-MT-010** - LCB - 23W - 120V,277V - 0-10V

**LCB-23W-MT-010-ARC** - LCB - 23W - 120V,277V - 0-10V (%0.1 - 100)

**LCB-27W-MT-010** - LCB - 27W - 120V,277V - 0-10V

**LCB-34W-MT-010** - LCB - 34W - 120V,277V - 0-10V

**LCB-34W-MT-010-ARC** - LCB - 34W - 120V,277V - 0-10V (%0.1 - 100)

**LCB-42W-MT-010** - LCB - 42W - 120V,277V - 0-10V

**LCB-42W-MT-010-ARC** - LCB - 42W - 120V,277V - 0-10V (%0.1 - 100)

**LCB-57W-MT-010** - LCB - 57W - 120V,277V - 0-10V

### 06 FINISHES

Standard Finishes

**BLP, BZP, WHP, SAP, BLW, BZW, WHW, VER**

Premium Finishes

**CMG, SMG, RMG, AMG, TXF, BCM, BGE, WCP, OCP, HUG, ABP, BPP,**

**SDS, WIR, CAP, CRM, AQW, NBP**

Brass Finishes

**MAB, POB, MIT**

Other - RAL

**RAL**

Other - Custom Color

**CUS**

**IMPORTANT: Driver wattage MUST match selected fixture wattage. (example: 12W Light Source = 12W Driver)"**

# In-grade HP2 - Round Grout Mask - Remote Driver - Brass

Date  Project  Type

## Drivers

Power Supply	Control	Input Voltage	Power Factor	THD (%)	Operation Ambient Temperature	InRush Current	Output Current	Output Power (Max-W)	Output Voltage (Range)	Dimming (Range)
LCB-10W-MT-010	010	120V,277V	0	0	-	-	350mA	15	21-32Vdc	1-100%
LCB-12W-MT-010	010	120V,277V	0.9	<20%	-	-	-	-	-	-
LCB-20W-MT-010	010	120V,277V	0.9	<20%	90°C	-	700mA	30	-	-
LCB-23W-MT-010	010	120V,277V	>0.9	<20	-20°C to 50°C	-	1050mA	50	2-55V	1-100%
LCB-23W-MT-010-ARC	010-ARC	120V,277V	>0.9	<20	-20°C to 50°C	-	1050mA	50	1.5-55V	0.1%-100%
LCB-27W-MT-010	010	120V,277V	>0.9	<20	-30°C to 90°C	-	250mA-1100mA	29.4	14-56v	1-100%
LCB-34W-MT-010	010	120V,277V	>0.9	<20	-20°C to 50°C	-	1050mA	50	2-55V	1-100%
LCB-34W-MT-010-ARC	010-ARC	120V,277V	>0.9	<20	-20°C to 50°C	-	1050mA	50	1.5-55V	0.1%-100%
LCB-42W-MT-010	010	120V,277V	>0.9	<20	-20°C to 50°C	-	1050mA	50	2-55V	1-100%
LCB-42W-MT-010-ARC	010-ARC	120V,277V	>0.9	<20	-20°C to 50°C	-	1050mA	50	1.5-55V	0.1%-100%
LCB-57W-MT-010	010	120V,277V	>0.90 @ 75-100% load	<20 @ 60-100% load	-30°C to 65°C	<30.0A Max	1400mA	75	18-54Vdc	10-100%

# In-grade HP2 - Round Grout Mask - Remote Driver - Brass

Date  Project  Type

## Technical

**Body:** Corrosion-free composite, made from high strength, thermo-formed, sheet molded polyester compound. Glass reinforced, flame retardant with knockout plugs and four (4) side flats for 1/2" or 3/4" conduit adapters.

**Material Detail:** Furnished in brass (360).

**Installation:** Integral, aluminum concrete pour collar (CPC) permits direct burial in soil or concrete. Consult Drainage Installation Guide for In-Grade Fixtures (DIG-IT) for compliance with proper soil preparation and drainage requirements prior to installation.

**Finish:** Standard Finishes, Premium Finishes, Brass Finishes, Other - RAL, Other - Custom Color

**Note:** Drivers are fixture specific. Driver wattage should match fixture wattage. For questions about driver selection, please contact the factory.

**Finish Detail:** Powder coat or metal finish options available for brass material.

**Warranty:** 5-year limited warranty.

**Certification:** UL tested to IESNA LM-79. UL Listed. Certified to CAN/CSA/ANSI Standards.

**IMPORTANT: Driver wattage MUST match selected fixture wattage. (example: 12W Light Source = 12W Driver)"**

# In-grade HP2 - Round Grout Mask - Remote Driver - Brass

Date

Project

Type

## Finishes

### STANDARD FINISHES



[BLP] Satin Black



[BZP] Satin Bronze



[WHP] Satin White

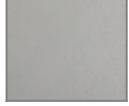

[SAP] Satin Aluminum



[BLW] Black Wrinkle



[BZW] Bronze Wrinkle



[WHW] White Wrinkle



[VER] Verde

### PREMIUM FINISHES



[CMG] Cascade Mountain Granite



[SMG] Sierra Mountain Granite



[RMG] Rocky Mountain Granite



[AMG] Aleutian Mountain Granite



[TXF] Textured Forest

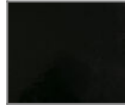

[BCM] Black Chrome

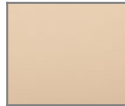

[BGE] Beige



[WCP] Weathered Copper



[OCP] Old Copper



[HUG] Hunter Green



[ABP] Antique Brass Powder



[BPP] Brown Patina Powder

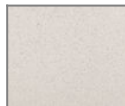

[SDS] Sonoran Desert Sandstone

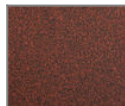

[WIR] Weathered Iron



[CAP] Clear Anodized Powder



[CRM] Cream



[AQW] Antique White

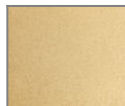

[NBP] Natural Brass Powder

### BRASS FINISHES



[MAB] Machined (Brass)



[POB] Polished (Brass)



[MIT] Mitique

### OTHER - RAL



[RAL] RAL Color

### OTHER - CUSTOM COLOR

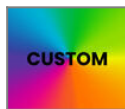

[CUS] Custom Color