

Driver Within Junction Box

In-grade HP2 - Square Grout Mask - Remote Driver - Brass

Date _____ Project _____ Type _____



IP68



IP68

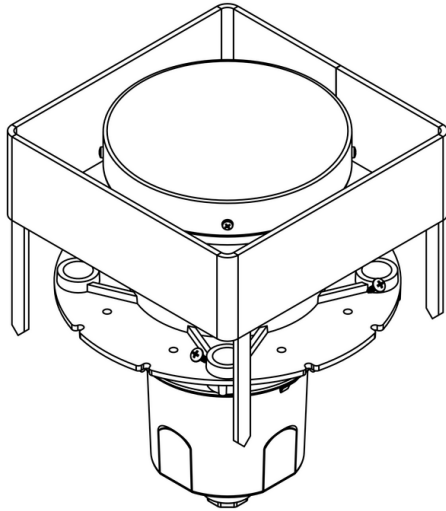

[Downloads](#)

[Product Image](#)

In-grade HP2 - Square Grout Mask - Remote Driver - Brass

Date Project Type

Configure

HP2 - **SG -** **DR-RM -** **BR -** **___ -** **___ -**
 01 02 03 04 05 06

In-grade HP2 - Square Grout Mask - Remote Driver - Brass

01 ACCESSORIES

HP2 - In-grade HP2

02 MOUNT

SG - Square Grout Mask

03 VERSION

DR-RM - Remote Driver

04 MATERIAL

BR - Brass

05 POWER SUPPLY

LCB-10W-MT-010 - LCB - 10W - 120V,277V - 0-10V

LCB-12W-MT-010 - LCB - 12W - 120V,277V - 0-10V

LCB-20W-MT-010 - LCB - 20W - 120V,277V - 0-10V

LCB-23W-MT-010 - LCB - 23W - 120V,277V - 0-10V

LCB-23W-MT-010-ARC - LCB - 23W - 120V,277V - 0-10V (%0.1 - 100)

LCB-27W-MT-010 - LCB - 27W - 120V,277V - 0-10V

LCB-34W-MT-010 - LCB - 34W - 120V,277V - 0-10V

LCB-34W-MT-010-ARC - LCB - 34W - 120V,277V - 0-10V (%0.1 - 100)

LCB-42W-MT-010 - LCB - 42W - 120V,277V - 0-10V

LCB-42W-MT-010-ARC - LCB - 42W - 120V,277V - 0-10V (%0.1 - 100)

LCB-57W-MT-010 - LCB - 57W - 120V,277V - 0-10V

06 FINISHES

Standard Finishes

BLP, BZP, WHP, SAP, BLW, BZW, WHW, VER

Premium Finishes

CMG, SMG, RMG, AMG, TXF, BCM, BGE, WCP, OCP, HUG, ABP, BPP,

SDS, WIR, CAP, CRM, AQW, NBP

Brass Finishes

MAB, POB, MIT

Other - RAL

RAL

Other - Custom Color

CUS

IMPORTANT: Driver wattage MUST match selected fixture wattage. (example: 12W Light Source = 12W Driver)"

In-grade HP2 - Square Grout Mask - Remote Driver - Brass

Date Project Type

Drivers

Power Supply	Control	Input Voltage	Power Factor	THD (%)	Operation Ambient Temperature	InRush Current	Output Current	Output Power (Max-W)	Output Voltage (Range)	Dimming (Range)
LCB-10W-MT-010	010	120V,277V	0	0	-	-	350mA	15	21-32Vdc	1-100%
LCB-12W-MT-010	010	120V,277V	0.9	<20%	-	-	-	-	-	-
LCB-20W-MT-010	010	120V,277V	0.9	<20%	90°C	-	700mA	30	-	-
LCB-23W-MT-010	010	120V,277V	>0.9	<20	-20°C to 50°C	-	1050mA	50	2-55V	1-100%
LCB-23W-MT-010-ARC	010-ARC	120V,277V	>0.9	<20	-20°C to 50°C	-	1050mA	50	1.5-55V	0.1%-100%
LCB-27W-MT-010	010	120V,277V	>0.9	<20	-30°C to 90°C	-	250mA-1100mA	29.4	14-56v	1-100%
LCB-34W-MT-010	010	120V,277V	>0.9	<20	-20°C to 50°C	-	1050mA	50	2-55V	1-100%
LCB-34W-MT-010-ARC	010-ARC	120V,277V	>0.9	<20	-20°C to 50°C	-	1050mA	50	1.5-55V	0.1%-100%
LCB-42W-MT-010	010	120V,277V	>0.9	<20	-20°C to 50°C	-	1050mA	50	2-55V	1-100%
LCB-42W-MT-010-ARC	010-ARC	120V,277V	>0.9	<20	-20°C to 50°C	-	1050mA	50	1.5-55V	0.1%-100%
LCB-57W-MT-010	010	120V,277V	>0.90 @ 75-100% load	<20 @ 60-100% load	-30°C to 65°C	<30.0A Max	1400mA	75	18-54Vdc	10-100%

In-grade HP2 - Square Grout Mask - Remote Driver - Brass

Date Project Type

Technical

Body: Corrosion-free composite, made from high strength, thermo-formed, sheet molded polyester compound. Glass reinforced, flame retardant with knockout plugs and four (4) side flats for 1/2" or 3/4" conduit adapters.

Material Detail: Furnished in brass (360).

Installation: Integral, aluminum concrete pour collar (CPC) permits direct burial in soil or concrete. Consult Drainage Installation Guide for In-Grade Fixtures (DIG-IT) for compliance with proper soil preparation and drainage requirements prior to installation.

Finish: Standard Finishes, Premium Finishes, Brass Finishes, Other - RAL, Other - Custom Color

Note: Drivers are fixture specific. Driver wattage should match fixture wattage. For questions about driver selection, please contact the factory.

Finish Detail: Powder coat or metal finish options available for brass material.

Warranty: 5-year limited warranty.

Certification: UL tested to IESNA LM-79. UL Listed. Certified to CAN/CSA/ANSI Standards.

IMPORTANT: Driver wattage MUST match selected fixture wattage. (example: 12W Light Source = 12W Driver)"

In-grade HP2 - Square Grout Mask - Remote Driver - Brass

Date

Project

Type

Finishes

STANDARD FINISHES



[BLP] Satin Black

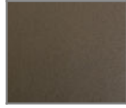

[BZP] Satin Bronze



[WHP] Satin White



[SAP] Satin Aluminum



[BLW] Black Wrinkle



[BZW] Bronze Wrinkle



[WHW] White Wrinkle



[VER] Verde

PREMIUM FINISHES



[CMG] Cascade Mountain Granite



[SMG] Sierra Mountain Granite



[RMG] Rocky Mountain Granite



[AMG] Aleutian Mountain Granite



[TXF] Textured Forest



[BCM] Black Chrome

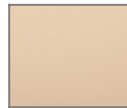

[BGE] Beige



[WCP] Weathered Copper



[OCP] Old Copper



[HUG] Hunter Green



[ABP] Antique Brass Powder



[BPP] Brown Patina Powder

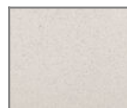

[SDS] Sonoran Desert Sandstone

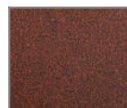

[WIR] Weathered Iron



[CAP] Clear Anodized Powder



[CRM] Cream



[AQW] Antique White

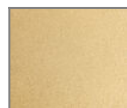

[NBP] Natural Brass Powder

BRASS FINISHES



[MAB] Machined (Brass)



[POB] Polished (Brass)



[MIT] Mitique

OTHER - RAL



[RAL] RAL Color

OTHER - CUSTOM COLOR

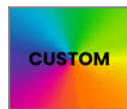

[CUS] Custom Color