

Transformer within Junction Box

Universal Power Module PM1 - Tree Strap Mount - 72" - With Safety Cable and Mounting Brackets - Remote Transformer - Aluminum

Date

Project

Type

Page: 1 of 5



IP66

RoHS



[Downloads](#)

[Product Image](#)

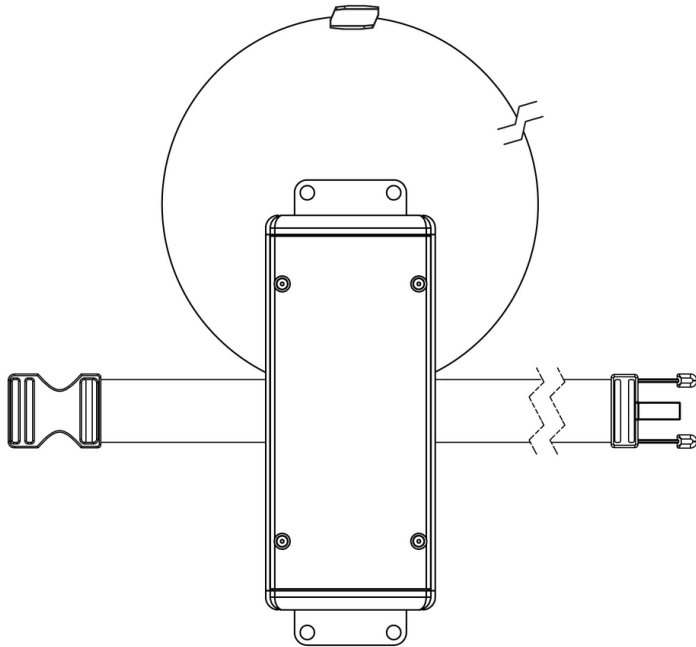

Universal Power Module PM1 - Tree Strap Mount - 72" - With Safety Cable and Mounting Brackets - Remote Transformer - Aluminum

Date Project Type

Configure

PM1 - 01 TS-72-MB - 02 TR-RM - 03 AL - 04 ___ - 05 ___ - 06

Universal Power Module PM1 - Tree Strap Mount - 72" - With Safety Cable and Mounting Brackets - Remote Transformer - Aluminum

01 ACCESSORIES

PM1 - Universal Power Module PM1

02 MOUNT

TS-72-MB - Tree Strap Mount - 72" - With Safety Cable and Mounting Brackets

03 VERSION

TR-RM - Remote Transformer

04 MATERIAL

AL - Aluminum

05 POWER SUPPLY

TRe20-MT-NON - 20W - 120V to 277V - Non-dimming

TRSS75-120-ELV - 60W - 120V - ELV Dimming

TRSS75-277-NON - 75W - 277V - Non-dimming

06 FINISHES

Standard Finishes

BLP, BZP, WHP, SAP, BLW, BZW, WHW, VER

Premium Finishes

CMG, SMG, RMG, AMG, TXF, BCM, BGE, WCP, OCP, HUG, ABP, BPP,

SDS, WIR, CAP, CRM, AQW, NBP

Other - RAL

RAL

Other - Custom Color

CUS

IMPORTANT: Transformer wattage MUST be calculated based on the total load of the luminaires it will support.

Universal Power Module PM1 - Tree Strap Mount - 72" - With Safety Cable and Mounting Brackets - Remote Transformer - Aluminum

Date Project Type

Transformers

Power Supply	Control	Max Load (W)	Input Voltage	Power Factor	THD (%)	Operation Ambient Temperature	Output Current	Circuit Breaker	Min Load (W)
TRe20-MT-NON	NON	20	-	90		-30°C to 90°C	15VDC +/-5%	-	1
TRSS75-120-ELV	ELV	60	120V	95		-30°C to 90°C	12VAC	-	0
TRSS75-277-NON	NON	60	277V	95	13	40°C	12VDC	-	0

Universal Power Module PM1 - Tree Strap Mount - 72" - With Safety Cable and Mounting Brackets - Remote Transformer - Aluminum

Date

Project

Type

Technical

Body: Furnished in copper-free aluminum (6061-T6).

Material Detail: Furnished in copper-free aluminum (6061-T6).

Installation: Tree Strap mounting system facilitates non-invasive installation. Adjustable nylon strap is mold and mildew resistant and will not hinder tree growth. Stainless steel safety cable maintains UPM mounting when nylon strap is disengaged.

Finish: Standard Finishes, Premium Finishes, Other - RAL, Other - Custom Color

Note: All line and low voltage connections must be made in compliance with the National Electrical Code. Failure to do so will void warranty.

Finish Detail: StarGuard, our 15-stage chromate-free process, cleans and conversion coats aluminum components prior to application of Class 'A' TGIC polyester powder coating. It is RoHS compliant.

Warranty: 5-year limited warranty.

Certification: RoHS compliant components., UL tested to IESNA LM-79. UL Listed. Certified to CAN/CSA/ANSI Standards.

IMPORTANT: Transformer wattage MUST be calculated based on the total load of the luminaires it will support.

Universal Power Module PM1 - Tree Strap Mount - 72" - With Safety Cable and Mounting Brackets - Remote Transformer - Aluminum

Date Project Type

Finishes

STANDARD FINISHES



PREMIUM FINISHES

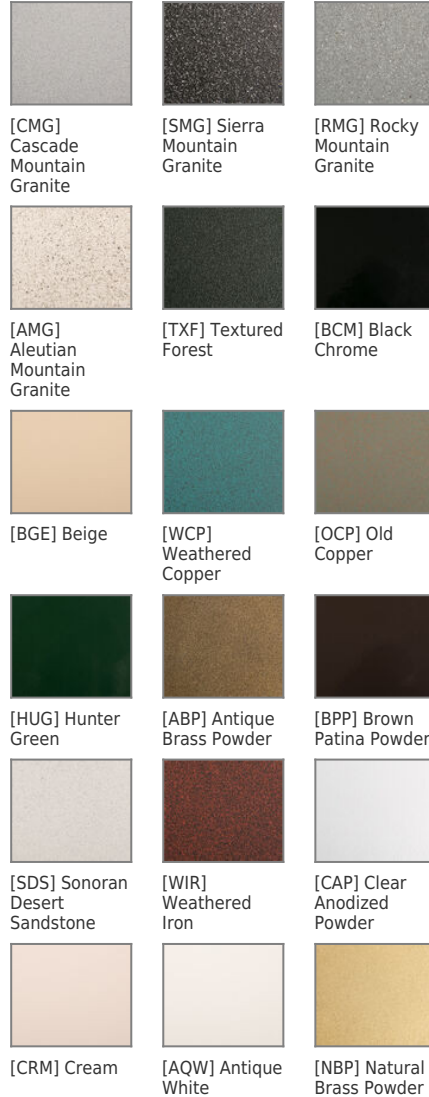

OTHER - RAL



OTHER - CUSTOM COLOR

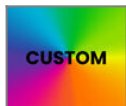

[CUS] Custom Color