

# Universal Power Module PM2 - Surface Mount - Remote Driver - Aluminum

Date \_\_\_\_\_ Project \_\_\_\_\_ Type \_\_\_\_\_



IP66

RoHS

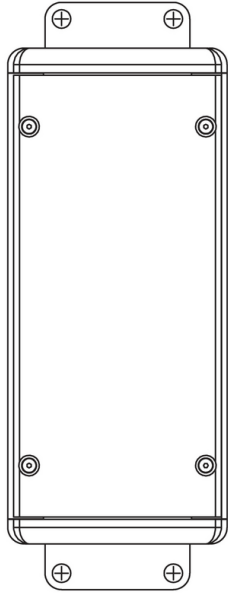

### Downloads

- Product Image
- Technical Drawing
- 2D (.dwg)
- 2D (.dxf)

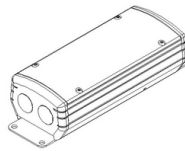
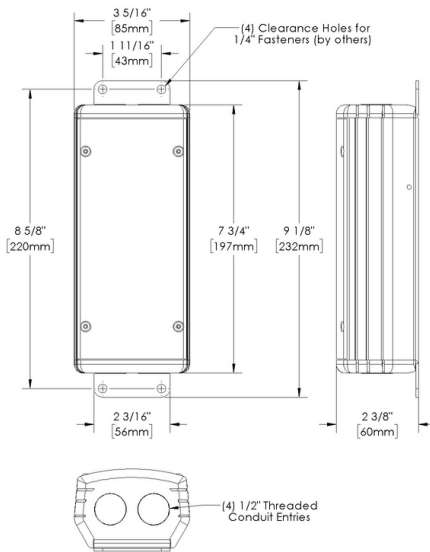

PM2 - SURFACE MOUNT

# Universal Power Module PM2 - Surface Mount - Remote Driver - Aluminum

Date  Project  Type

## Configure

**PM2 -** **SM -** **DR-RM -** **AL -** **\_\_\_ -** **\_\_\_ -**  
 01 02 03 04 05 06

Universal Power Module PM2 - Surface Mount - Remote Driver - Aluminum

### 01 ACCESSORIES

**PM2** - Universal Power Module PM2

### 02 MOUNT

**SM** - Surface Mount

### 03 VERSION

**DR-RM** - Remote Driver

### 04 MATERIAL

**AL** - Aluminum

### 05 POWER SUPPLY

**LCB-10W-MT-010** - LCB - 10W - 120V,277V - 0-10V

**LCB-10W-MT-ELV** - LCB - 10W - 120V,277V - ELV Dimming (120V dimming only)

**LCB-10W-MT-INC** - LCB - 10W - 120V,277V - INC Dimming (120V dimming only)

**LCB-12W-MT-010** - LCB - 12W - 120V,277V - 0-10V

**LCB-12W-MT-ELV** - LCB - 12W - 120V,277V - ELV Dimming (120V dimming only)

**LCB-12W-MT-INC** - LCB - 12W - 120V,277V - INC Dimming (120V dimming only)

**LCB-20W-MT-010** - LCB - 20W - 120V,277V - 0-10V

**LCB-20W-MT-ELV** - LCB - 20W - 120V,277V - ELV Dimming (120V dimming only)

**LCB-20W-MT-INC** - LCB - 20W - 120V,277V - INC Dimming (120V dimming only)

**LCB-27W-MT-010** - LCB - 27W - 120V,277V - 0-10V

**LCB-27W-MT-ELV** - LCB - 27W - 120V,277V - ELV Dimming (120V dimming only)

**LCB-27W-MT-INC** - LCB - 27W - 120V,277V - INC Dimming (120V dimming only)

### 06 FINISHES

Standard Finishes

**BLP, BZP, WHP, SAP, BLW, BZW, WHW, VER**

Premium Finishes

**CMG, SMG, RMG, AMG, TXF, BCM, BGE, WCP, OCP, HUG, ABP, BPP,**

**SDS, WIR, CAP, CRM, AQW, NBP**

Other - RAL

**RAL**

Other - Custom Color

**CUS**

**IMPORTANT: Driver wattage MUST match selected fixture wattage. (example: 12W Light Source = 12W Driver)"**

## Universal Power Module PM2 - Surface Mount - Remote Driver - Aluminum

Date  Project  Type

### Drivers

Power Supply	Control	Input Voltage	Power Factor	THD (%)	Operation Ambient Temperature	InRush Current	Output Current	Output Power (Max-W)	Output Voltage (Range)	Dimming (Range)
LCB-10W-MT-010	010	120V,277V	0	0	-	-	350mA	15	21-32Vdc	1-100%
LCB-10W-MT-ELV	ELV	120V	0	0	-	-	350mA	15	21-32Vdc	1-100%
LCB-12W-MT-010	010	120V,277V	0.9	<20%	-	-	-	-	-	-
LCB-12W-MT-ELV	ELV	120V	0.9	<20%	-	-	700mA	30	-	-
LCB-12W-MT-INC	INC	120V,277V	-	-	-	-	-	-	-	-
LCB-20W-MT-010	010	120V,277V	0.9	<20%	90°C	-	700mA	30	-	-
LCB-20W-MT-ELV	ELV	120V	0.9	<20%	-	-	700mA	30	-	-
LCB-20W-MT-INC	INC	120V	1000	1000	-	1000	700mA	21	20-30Vdc	1-100%
LCB-27W-MT-010	010	120V,277V	>0.9	<20	-30°C to 90°C	-	250mA-1100mA	29.4	14-56v	1-100%
LCB-27W-MT-ELV	ELV	120V,277V	>0.9	<20	-30°C to 90°C	-	250mA-1100mA	29.4	14-56v	1-100%
LCB-27W-MT-INC	INC	120V,277V	>0.9	<20	-30°C to 90°C	-	250mA-1100mA	29.4	14-56v	1-100%

# Universal Power Module PM2 - Surface Mount - Remote Driver - Aluminum

Date  Project  Type

## Technical

**Body:** Furnished in copper-free aluminum (6061-T6).

**Material Detail:** Furnished in copper-free aluminum (6061-T6).

**Installation:** For use with side entry, surface conduits. Mounting brackets to anchor to architectural surface. Stainless steel cable with integral loop allows cover to suspend from housing during installation to simplify wire connection and component attachment.

**Finish:** Standard Finishes, Premium Finishes, Other - RAL, Other - Custom Color

**Note:** Drivers are fixture specific. Driver wattage should match fixture wattage. For questions about driver selection, please contact the factory.

**Finish Detail:** StarGuard, our 15-stage chromate-free process, cleans and conversion coats aluminum components prior to application of Class 'A' TGIC polyester powder coating. It is RoHS compliant.

**Warranty:** 5-year limited warranty.

**Certification:** RoHS compliant components., UL tested to IESNA LM-79. UL Listed. Certified to CAN/CSA/ANSI Standards.

**IMPORTANT: Driver wattage MUST match selected fixture wattage. (example: 12W Light Source = 12W Driver)"**

# Universal Power Module PM2 - Surface Mount - Remote Driver - Aluminum

Date  Project  Type

## Finishes

### STANDARD FINISHES



[BLP] Satin Black

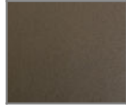

[BZP] Satin Bronze



[WHP] Satin White



[SAP] Satin Aluminum



[BLW] Black Wrinkle



[BZW] Bronze Wrinkle



[WHW] White Wrinkle



[VER] Verde

### PREMIUM FINISHES



[CMG] Cascade Mountain Granite



[SMG] Sierra Mountain Granite



[RMG] Rocky Mountain Granite



[AMG] Aleutian Mountain Granite



[TXF] Textured Forest



[BCM] Black Chrome

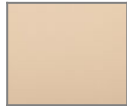

[BGE] Beige



[WCP] Weathered Copper



[OCP] Old Copper



[HUG] Hunter Green



[ABP] Antique Brass Powder



[BPP] Brown Patina Powder

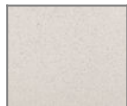

[SDS] Sonoran Desert Sandstone



[WIR] Weathered Iron



[CAP] Clear Anodized Powder



[CRM] Cream



[AQW] Antique White

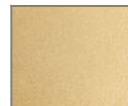

[NBP] Natural Brass Powder

### OTHER - RAL



[RAL] RAL Color

### OTHER - CUSTOM COLOR



[CUS] Custom Color