

Universal Power Module PM2 - Tree Strap Mount - 24" - With Safety Cable and Mounting Brackets - Single - Offset - Aluminum

Date

Project

Type



IP66

RoHS



[Downloads](#)

[Product Image](#)

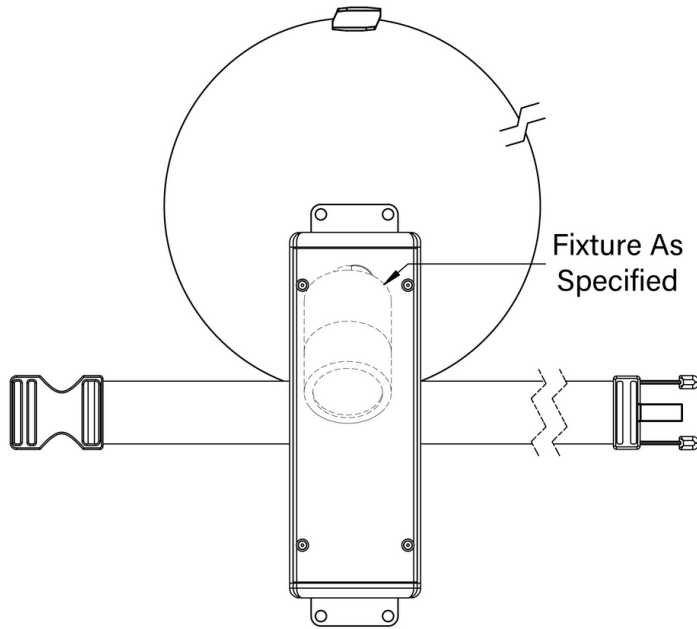

Universal Power Module PM2 - Tree Strap Mount - 24" - With Safety Cable and Mounting Brackets - Single - Offset - Aluminum

Date Project Type

Configure

PM2 - **TS-24-MB -** **SO -** **AL -** **___ -**
 01 02 03 04 06

Universal Power Module PM2 - Tree Strap Mount - 24" - With Safety Cable and Mounting Brackets - Single - Offset - Aluminum

01 ACCESSORIES

PM2 - Universal Power Module PM2

02 MOUNT

TS-24-MB - Tree Strap Mount - 24" - With Safety Cable and Mounting Brackets

03 VERSION

SO - Single - Offset

04 MATERIAL

AL - Aluminum

06 FINISHES

Standard Finishes

BLP, BZP, WHP, SAP, BLW, BZW, WHW, VER

Premium Finishes

CMG, SMG, RMG, AMG, TXF, BCM, BGE, WCP, OCP, HUG, ABP, BPP, SDS, WIR, CAP, CRM, AQW, NBP

Other - RAL

RAL

Other - Custom Color

CUS

Universal Power Module PM2 - Tree Strap Mount - 24" - With Safety Cable and Mounting Brackets - Single - Offset - Aluminum

Date

Project

Type

Technical

Body: Furnished in copper-free aluminum (6061-T6).

Material Detail: Furnished in copper-free aluminum (6061-T6).

Installation: Tree Strap mounting system facilitates non-invasive installation. Adjustable nylon strap is mold and mildew resistant and will not hinder tree growth. Stainless steel safety cable maintains UPM mounting when nylon strap is disengaged.

Finish: Standard Finishes, Premium Finishes, Other - RAL, Other - Custom Color

Finish Detail: StarGuard, our 15-stage chromate-free process, cleans and conversion coats aluminum components prior to application of Class 'A' TGIC polyester powder coating. It is RoHS compliant.

Warranty: 5-year limited warranty.







Certification: RoHS compliant components., UL tested to IESNA LM-79. UL Listed. Certified to CAN/CSA/ANSI Standards.

Universal Power Module PM2 - Tree Strap Mount - 24" - With Safety Cable and Mounting Brackets - Single - Offset - Aluminum

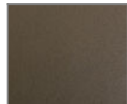









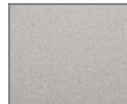

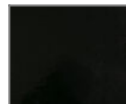

Date Project Type

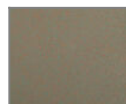
Finishes

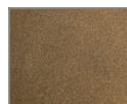
STANDARD FINISHES

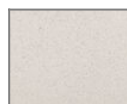
 [BLP] Satin Black	 [BZP] Satin Bronze	 [WHP] Satin White
 [SAP] Satin Aluminum	 [BLW] Black Wrinkle	 [BZW] Bronze Wrinkle
 [WHW] White Wrinkle	 [VER] Verde	

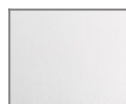
PREMIUM FINISHES

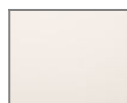
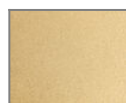
 [CMG] Cascade Mountain Granite	 [SMG] Sierra Mountain Granite	 [RMG] Rocky Mountain Granite
 [AMG] Aleutian Mountain Granite	 [TXF] Textured Forest	 [BCM] Black Chrome
 [BGE] Beige	 [WCP] Weathered Copper	 [OCP] Old Copper
 [HUG] Hunter Green	 [ABP] Antique Brass Powder	 [BPP] Brown Patina Powder
 [SDS] Sonoran Desert Sandstone	 [WIR] Weathered Iron	 [CAP] Clear Anodized Powder
 [CRM] Cream	 [AQW] Antique White	 [NBP] Natural Brass Powder

OTHER - RAL



[RAL] RAL Color

OTHER - CUSTOM COLOR

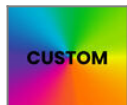

[CUS] Custom Color