

Date Project Type

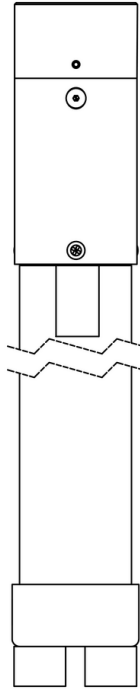

RoHS



Downloads

- Product Image
- Technical Drawing
- 2D (.dwg)
- 2D (.dxf)

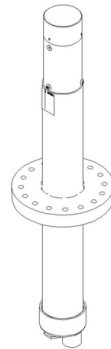
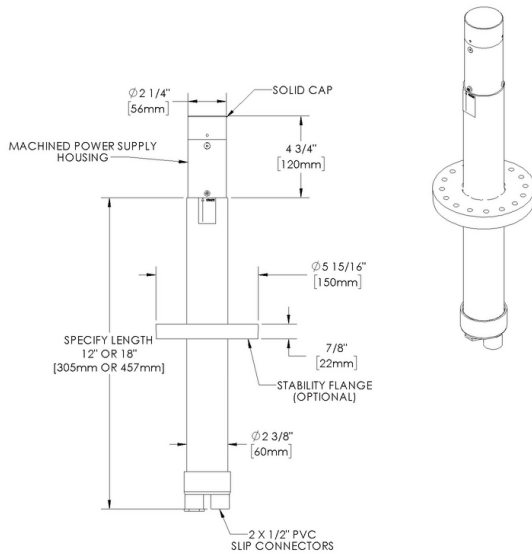

PP1-JUNCTION-CC

Power Pipe PP1 - 18" Junction Box - Remote Transformer - Stainless Steel

(formerly Power Pipe / PP with TRSS75 or TRe20)

Date	Project	Type
<input type="text"/>	<input type="text"/>	<input type="text"/>

Configure

PP1 - **J18 -** **TR-RM -** **SS -** **___ -** **___ -**
 01 02 03 04 05 06

Power Pipe PP1 - 18" Junction Box - Remote Transformer - Stainless Steel

01 ACCESSORIES

PP1 - Power Pipe PP1

02 MOUNT

J18 - 18" Junction Box

03 VERSION

TR-RM - Remote Transformer

04 MATERIAL

SS - Stainless Steel

05 POWER SUPPLY

TRe20-MT-NON - 20W - 120V to 277V - Non-dimming

TRSS75-120-ELV - 60W - 120V - ELV Dimming

TRSS75-277-NON - 75W - 277V - Non-dimming

06 FINISHES

Stainless Steel Finishes

MAS, POS

IMPORTANT: Transformer wattage MUST be calculated based on the total load of the luminaires it will support.

Power Pipe PP1 - 18" Junction Box - Remote Transformer - Stainless Steel

(formerly Power Pipe / PP with TRSS75 or TRe20)

Date Project Type

Transformers

Power Supply	Control	Max Load (W)	Input Voltage	Power Factor	THD (%)	Operation Ambient Temperature	Output Current	Circuit Breaker	Min Load (W)
TRe20-MT-NON	NON	20	-	90		-30°C to 90°C	15VDC +/-5%	-	1
TRSS75-120-ELV	ELV	60	120V	95		-30°C to 90°C	12VAC	-	0
TRSS75-277-NON	NON	60	277V	95	13	40°C	12VDC	-	0

Power Pipe PP1 - 18" Junction Box - Remote Transformer - Stainless Steel

(formerly Power Pipe / PP with TRSS75 or TRe20)

Date	Project	Type
<input type="text"/>	<input type="text"/>	<input type="text"/>

Technical

Body: Machined cap and power supply housing. Stainless steel hardware. High temperature, silicone 'O' Ring provides watertight seal.

Material Detail: Furnished in stainless steel (304).

Installation: Stability Flange included., 2" Schedule 80 PVC pipe. For direct burial in soil or concrete. Includes two (2) 1/2" PVC slip connectors for branch circuit wiring.

Finish: Stainless Steel Finishes

Finish Detail: Metal finish option only for stainless steel material.

Warranty: 5-year limited warranty.

Certification: RoHS compliant components., UL tested to IESNA LM-79. UL Listed. Certified to CAN/CSA/ANSI Standards.

IMPORTANT: Transformer wattage MUST be calculated based on the total load of the luminaires it will support.

Date

Project

Type

Finishes

STAINLESS STEEL FINISHES



[MAS]
Machined
(Stainless
Steel)



[POS] Polished
(Stainless
Steel)