

CONNECT

new product highlight

Custom Hume Poles
Houston, TX
Lighting Design: Dot Dash
Photo Credit: Alfredo Diaz



SPRING/SUMMER 2026

B-K LIGHTING®

B-K40 LIGHTING

CONNECT WITH US AND
OUR NEW PRODUCTS

NITE STAR & ESSENTIALS	4
RIO WALL MOUNT	6
RIO LAZR	8
RIO	10
HUME®	12
POLES	14
POLE TOP	16
MINI YUKON® BOLLARD	18
MINI YUKON®	20
YUKON® BOLLARD	22
YUKON® STEPLIGHT	24
DEMI	26
COMING SOON	28
CUSTOMS	30





THE NEW NITE STAR &

FIVE OPTIC OPTIONS

12°, 23°, 34°, 57°, 12x42°

LIGHT SOURCE OPTIONS

10W; Up to 588 Lumens;
2700K, 3000K, 3500K, & 4000K

AVAILABLE IN 80 OR 90 CRI

ADJUST-E-LUME

Individual output
control at the fixture

LIGHT SOURCE OPTIONS

8W; Up to 464 Lumens;
2700K & 3000K

AVAILABLE IN 80 OR 90 CRI

B 3 MATERIAL OPTIONS

Aluminum, Brass, or Stainless

B 360SL NOW STANDARD

360° HORIZONTAL ROTATION

B Choose from eight (8) standard colors, 18 premium finishes, RAL match or custom color match

B Made in the USA with sustainable processes - 5 Year Limited Warranty



NITE STAR ESSENTIALS

B 6 CAP OPTIONS

FIVE OPTIC OPTIONS

12°, 23°, 35°, 59°, 12x42°

NITE STAR

The latest iteration of our immensely popular Nite Star fixture. This rework converted the prior 3-LED source board to a single LED source with optimized performance and distributions. With sustainability and modularity always on our mind, the new internals are compatible with existing fixture bodies and can easily be installed into previous models that came with the original 3-LED source.



NITE STAR ESSENTIALS

A continuation of our original Essentials line of products, the new Nite Star Essentials LED is designed to provide you with just that: the essentials of a high performing, quality, long-lasting luminaire. It's the perfect solution when the extras aren't needed and budget constraints are a reality.

**Non-dimming*

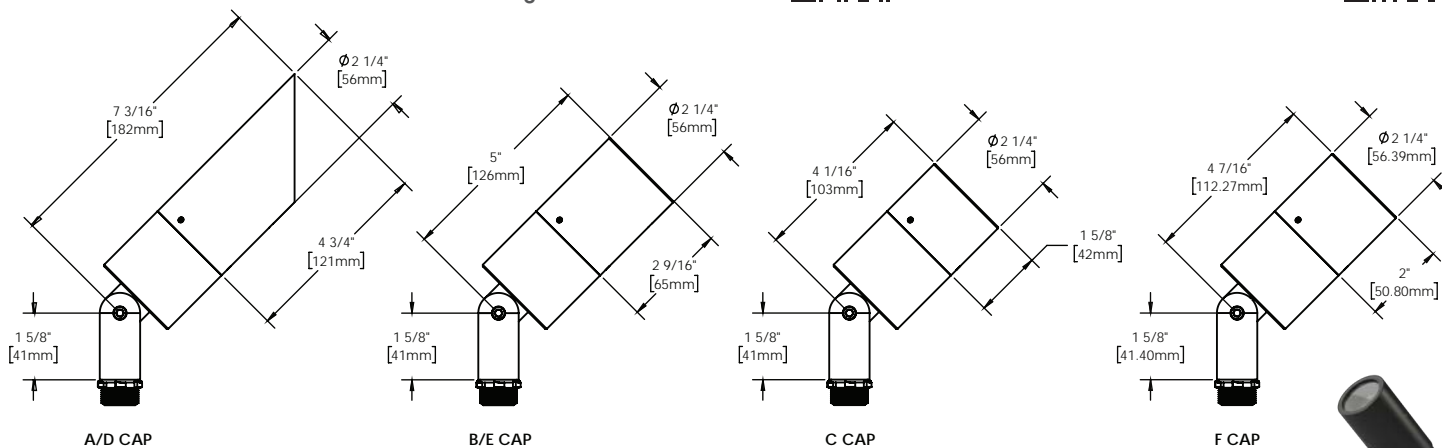

B APPLICABLE TO BOTH MODELS

7W ARTI STAR ALSO NOW AVAILABLE WITH THE NEW SINGLE SOURCE LED

RIO

WALL MOUNT

The **RIO** Line Continues to Grow.

Introducing new mounting options and configurations that expand Rio's architectural versatility. From wall to flood applications, Rio delivers cohesive performance and design across an expanding list of environments.

- Integral power supply
- 2700K, 3000K, 3500K and 4000K CCT; 80CRI and 90CRI options
- 6° very narrow spot, 13° narrow spot, 23° spot, 34° medium flood, and 56° wide flood optic options
- Dual model offers individually selectable LED and distribution options for both the up and down directions
- Choose from eight (8) standard colors, 18 premium finishes, RAL match or custom color match
- Made in the USA with sustainable processes - 5 Year Limited Warranty

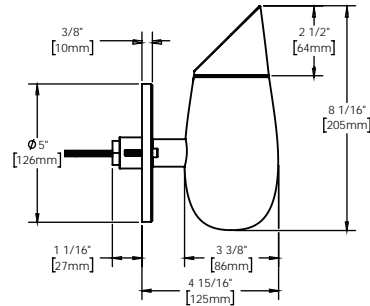

A/D Cap

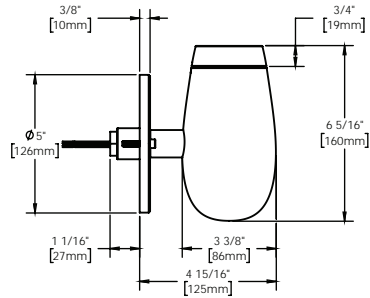

B/E Cap

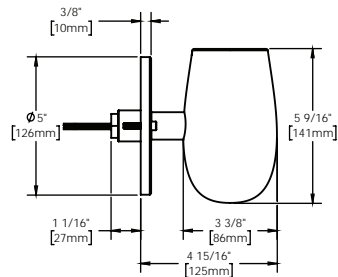

C Cap

WALL MOUNT

SINGLE



WALL MOUNT

DUAL



Architectural Simplicity.
Expanded Capability.

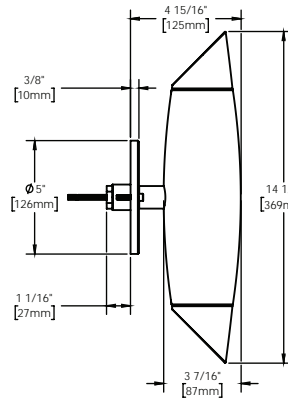

A/D CapB

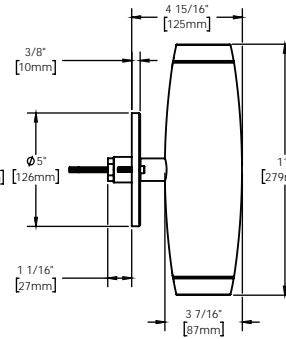

/E Cap

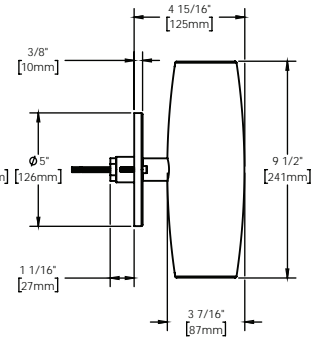

C Cap

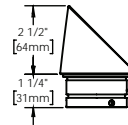

A/D Cap

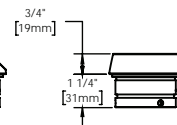

B/E CapC

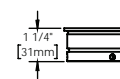

Cap

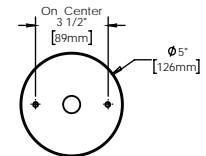

First and only floodlight to incorporate a

360 AIM & LOCK TECHNOLOGY

HIGH INTENSITY CENTER BEAM

Uniquely effective in illuminating towering facades and columns, and spotlighting over extended distances.

THREE OPTIC OPTIONS

4°, 5°, 8°

**14.5W LASER SOURCE
OVER 14,000 CANDELA**

6000K CCT



Parabolic

A/D CAP

B/E CAP

C CAP

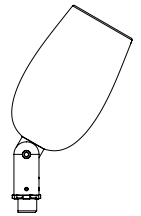
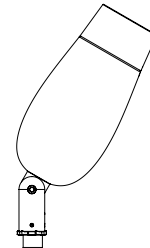

true laser diode source.

- Line Voltage; 120 – 277V
- Tamper Resistant Option
- Aim & lock knuckle eliminates need for adjustments
- 5 individual cap styles to choose from
- Choose from eight (8) standard, 18 premium finishes, RAL match or custom color match
- Made in the USA with sustainable processes - 5 Year Limited Warranty

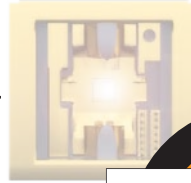

A/D CAP

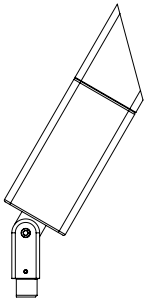

B/E CAP

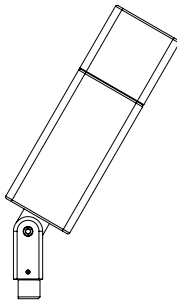

C CAP

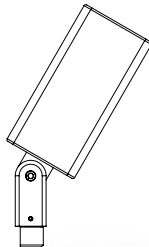

Square



SQUARE

D I O L A Z P
D I O L A Z P

RIO

High output illumination packaged within a delicate wine glass shaped body, or a modern angular square body—the Rio gives you the flexibility to pick and choose.



Parabolic

THREE CAP STYLES

Seamless body design

MODULAR OPTICS

6°, 13°, 23°, 34°, 56°

PARABOLIC PROFILE OPTION

SINGLE 14W LED
850 DELIVERED LUMENS

ELV, INC, AND 0-10V
DIMMING OPTIONS

360 AIM & LOCK
TECHNOLOGY

A/D CAP

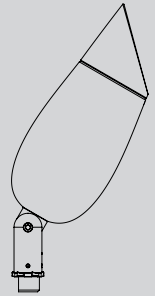

B/E CAP

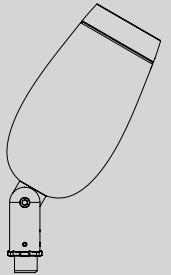

C CAP

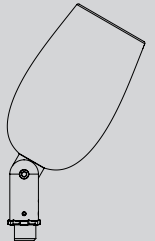

SQUARE RIO



Square

- Tamper Resistant Option
- Water-tight Anti-Siphon Plug & Anti-Condensation Vent protects internal components
- Modular design supports easy upgrades
- Choose from eight (8) standard, 18 premium finishes, RAL match or custom color match
- Made in the USA with sustainable processes - 5 Year Limited Warranty

SQUARE PROFILE OPTION



THREE CAP STYLES
Cohesive body design



A/D CAP

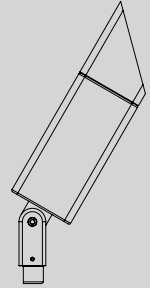

B/E CAP

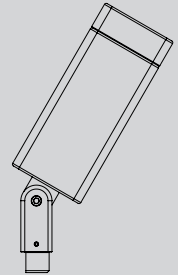

C CAP

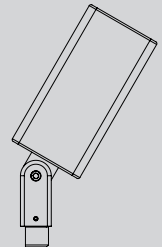

HUME®

A jack of all trades, our Hume® fixture is a simplistic styled luminaire that delivers remarkable performance and versatile mounting options for any interior or exterior application. Mount it on a wall, on a pole or recessed from up high and customize its throw for the illumination you want right where you want it.

- Integral power supply
- 2700K, 3000K, **3500K** and 4000K CCT
- 11° narrow spot and 25° narrow flood for more precise aiming or 43° flood and 56° wide flood for a wider beam spread
- Choose from eight (8) standard colors, 18 premium finishes, RAL match or custom color match
- Made in the USA with sustainable processes - 5 Year Limited Warranty

INTEGRAL DIMMING DRIVER

ELV, INC, or 0/10V
120-277 VAC

34 OR 36W; UP TO 3600 DELIVERED LUMENS

80 or 90 CRI with 4 CCT options

4" DIAMETER

WATER-TIGHT ANTI-SIPHON PLUG
& ANTI-CONDENSATION VENT

360 HD AIM/LOCK KNUCKLE



Floodlight



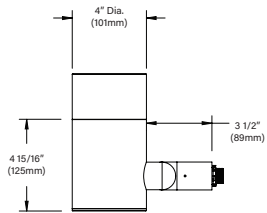
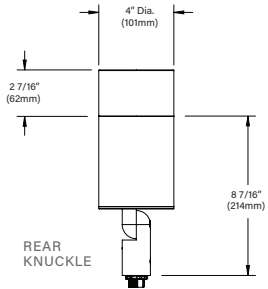

SIDE KNUCKLE

UPLIGHT HUME

The same quality and power as our Hume floodlight, now available as an uplight. Its range of narrow-spot optic to wide flood optic makes it ideal for illuminating various types of architecture.



Flush Mount

11 1/8"



Surface Mount

Convenience comes with acquiring both your pole and your fixtures from B-K Lighting. With square or round options at varying heights, our poles elevate the ambiance of parks, streetscapes, and architectural landscapes. Crafted with precision and designed for durability, you can expect quality every time.



POLES

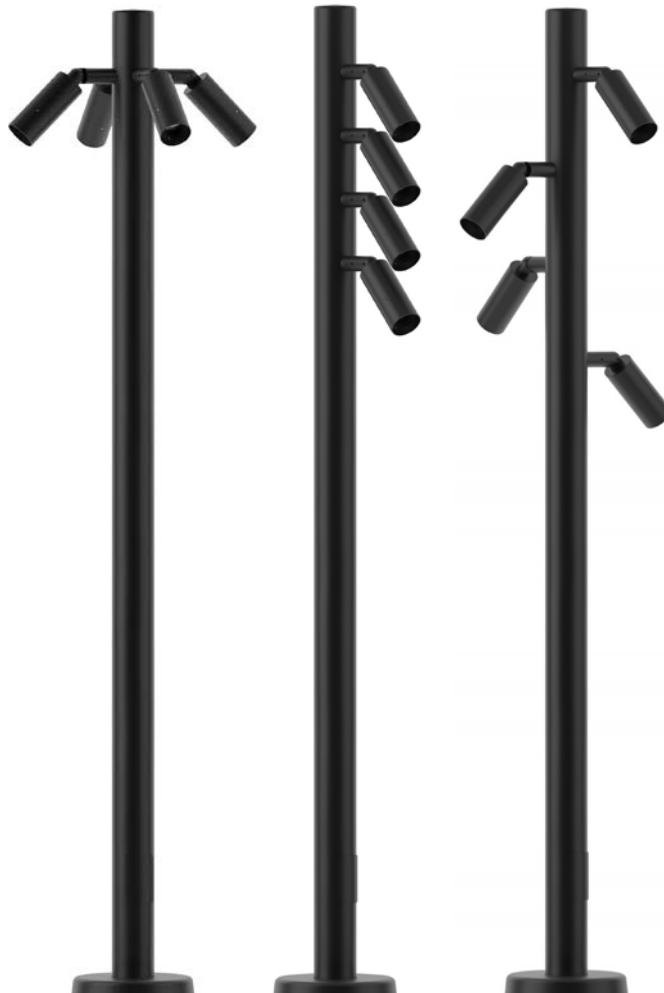

MOUNT UP TO 4 FIXTURES

Horizontal
Vertical
Spiral (90° clockwise spacing)

ROUND OR SQUARE POLE
4" DIAMETER
8', 10', 12', 16', 20' HEIGHT

Aluminum or steel

HANDHOLE COVER

14" From base of pole
2" X 4" (round pole)
3" X 5" (square pole)

*Available configurations may be limited based on pole height.



Hume Floodlights on Poles
 Heartland of America | Omaha, NE
 Lighting Design: Atelier Ten
 Photo Credit: Ryan Fischer



- 2700K, 3000K, 3500K and 4000K CCT; 80 or 90 CRI
- Choose from eight (8) standard colors, 18 premium finishes, RAL match or custom color match
- Made in the USA with sustainable processes - 5 Year Limited Warranty



HUME

34W & 36W
 Up to 14,500 delivered lumens (with 4 fixtures)
 ELV, INC, 0-10V dimming
 Four optic options



DENALI INTEGRAL

13W & 21W
 Up to 6500 delivered lumens (with 4 fixtures)
 ELV, INC, 0-10V dimming
 Three optic options



RIO

14W
 Up to 3400 delivered lumens (with 4 fixtures)
 ELV, INC, 0-10V dimming
 Five optic options

POLE TOP

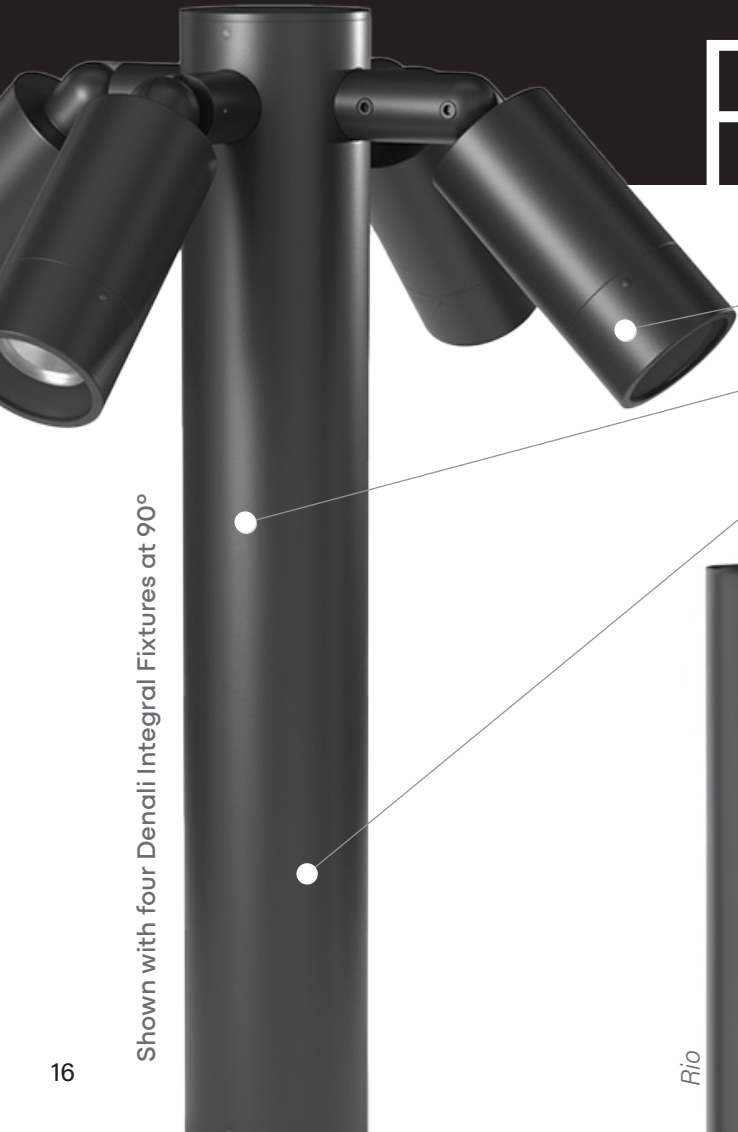

MOUNT UP TO 4 FIXTURES

ROUND POLE BODY

2 3/8" diameter & 24 1/4" height

MACHINED ALUMINUM SLIP FIT BASE FOR
USE WITH 2 3/8" DIA. X 4" TALL TENON

Shown with four Denalii Integral Fixtures at 90°

Rio

Denalii Integral

Hume



The Pole Top can be outfitted with the designer's choice of 3 different B-K floodlight models: Denali, Hume, or Rio. A product like this gives you the ability to modify an existing pole and add lighting precisely where desired.

- Rio: 14W; up to 3400 delivered lumens (4 fixtures)
- Denali Integral: 13W & 21W; up to 6500 delivered lumens (4 fixtures)
- Hume: 34W or 36W; up to 14,500 delivered lumens (4 fixtures)
- Multiple options for caps, optics, dimming and more
- 2700K, 3000K, 3500K and 4000K CCT
- Choose from eight (8) standard colors, 20 premium finishes, RAL match or custom color match
- Made in the USA with sustainable processes - 5 Year Limited Warranty

NOW AVAILABLE IN SPIRAL & VERTICAL OPTIONS



Rio Spiral



Rio Vertical



B-K Pole Top with Denali Fixtures
Cameron Plaza | Duke University
Photo Credit: Landscape Architecture by
Surface 678, PA; Photography by Art Howard
Photography



8W; OVER 500 DELIVERED LUMENS

80 or 90 CRI with 4 CCT options
7W amber option

LINE VOLTAGE DRIVER

ELV, INC, and 0-10V dimming
120 or 277 VAC

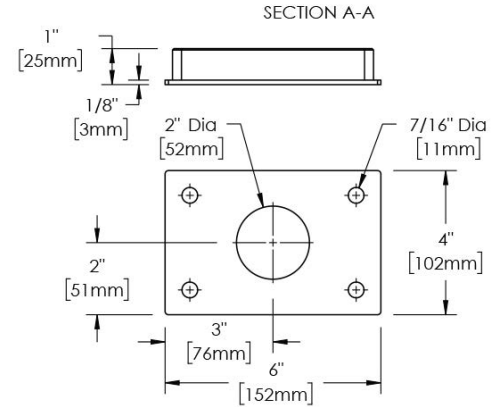

STANDARD ANCHOR BASE MOUNTING

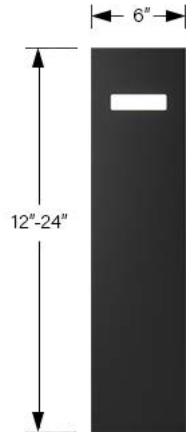

MINI
YUKON[®]
BOLLARD

The newest addition to the Yukon family, the Mini Yukon Bollard offers another solution to pathway lighting. Developed in response to requests for a more compact version of the Yukon Bollard, this new product's smaller stature offers functionality and versatility for a variety of applications.

- Available in 2700K, 3000K, 3500K and 4000K CCT

- Choose from eight (8) standard, 18 premium finishes, RAL match or custom color match

- Made in the USA with sustainable processes - 5 Year Limited Warranty

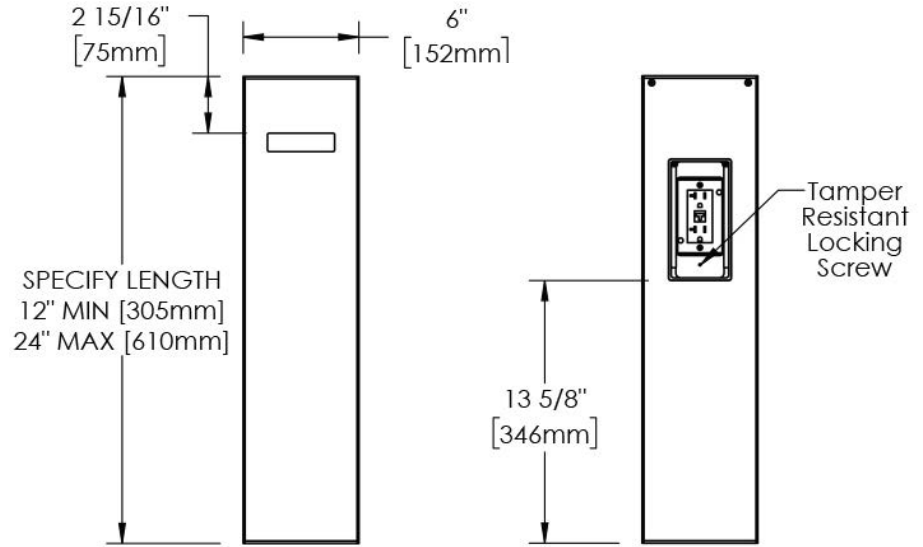

(RE1 Shown with Duplex-GFCI) (RE2 Shown with Duplex-Dual with USB)

**RECEPTACLE
LOCATED 18"
ABOVE GROUND**

Meets ADA require-
ments

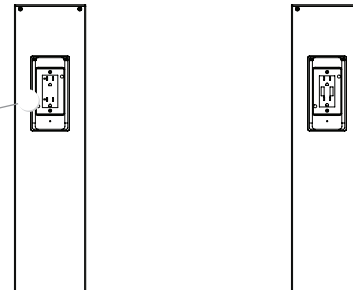



SIDE VIEW

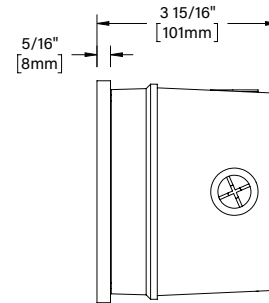

FRONT VIEW

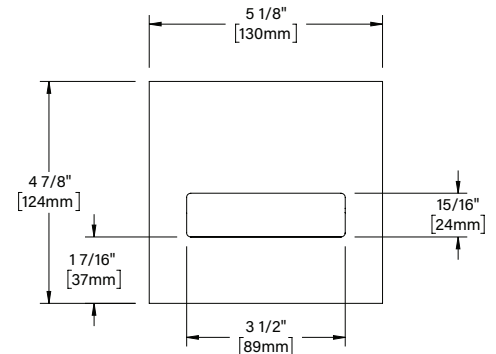

- Available in 2700K, 3000K, 3500K and 4000K CCT
- Choose from eight (8) standard, 18 premium finishes, RAL match or custom color match
- Made in the USA with sustainable processes - 5 Year Limited Warranty



2 GANG BOX

For installation in standard stud wall construction
7 entry holes with 3/4" threads, 6 plugs included

NO VISIBLE HARDWARE

8W; OVER 500 DELIVERED LUMENS

80 or 90 CRI with 4 CCT options
7W amber option
ELV, INC, and 0-10V dimming
120-277 VAC

TWO OPTIC ORIENTATIONS

Wide throw or forward throw



MINI YUKON[®]

Introducing a fresh take on our beloved Yukon steplight, the Mini Yukon. Engineered with the same commitment to resilience, functionality, and personalized options that define our products, the Mini Yukon steplight adds a touch of innovation to illuminate pathways and spaces with timeless style.

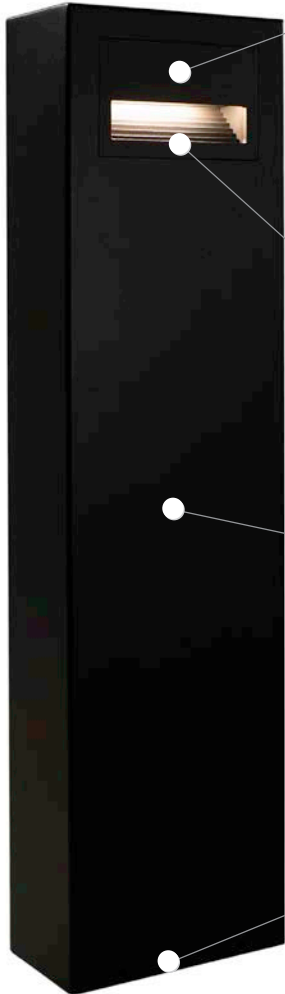

LINE VOLTAGE DRIVER

MT 120 or 277V
ELV, INC or 0-10V dimming

12W LED LINEAR ARRAY UP TO 480 DELIVERED LUMENS

80 OR 90 CRI with 4 CCT
options including 3500K

NOW AVAILABLE IN MULTIPLE HEIGHTS

Choose from 18", 24", 30",
36", and 42"

STAINLESS STEEL ANCHOR PLATE & MACHINED ALUMINUM BASE

Anchor kit can be shipped
ahead

YUKON[®] BOLLARD

The Yukon[®] Bollard utilizes the Yukon Indirect Steplight, offering a beautiful aesthetic match between the two when placed in proximity to one another. The Yukon delivers impressive performance in its wide soft forward lumination, and like all of our fixtures, is built to last.

IN-USE RECEPTACLE OPTION

Dual GFCI and USB
combinations available

RECEPTACLE LOCATED 15" ABOVE GROUND

Meets ADA require-
ments

18" to 42" H x 11" W x 6" D

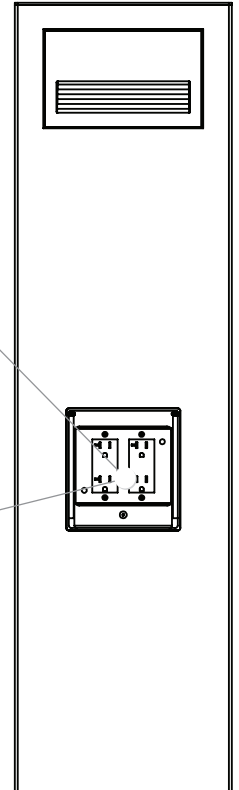

STANDARD & LOUVERED FACEPLATE OPTIONS



STANDARD

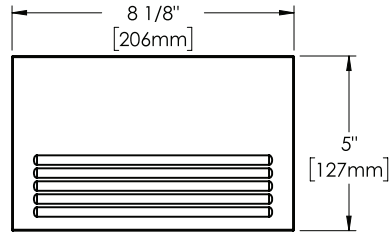

LOUVERED

TWO BACKPLATE OPTIONS

*Stepped for use with standard faceplate only.

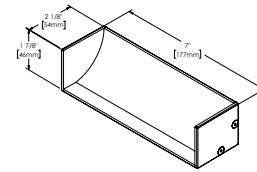

CURVED

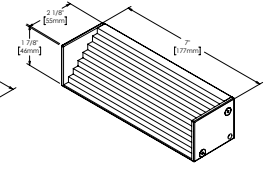

STEPPED*

- Tamper Resistant locking hardware
- Electrical quick disconnects permits field maintenance
- Choose from eight (8) standard, 18 premium finishes, RAL match or custom color match
- Made in the USA with sustainable processes - 5 Year Limited Warranty

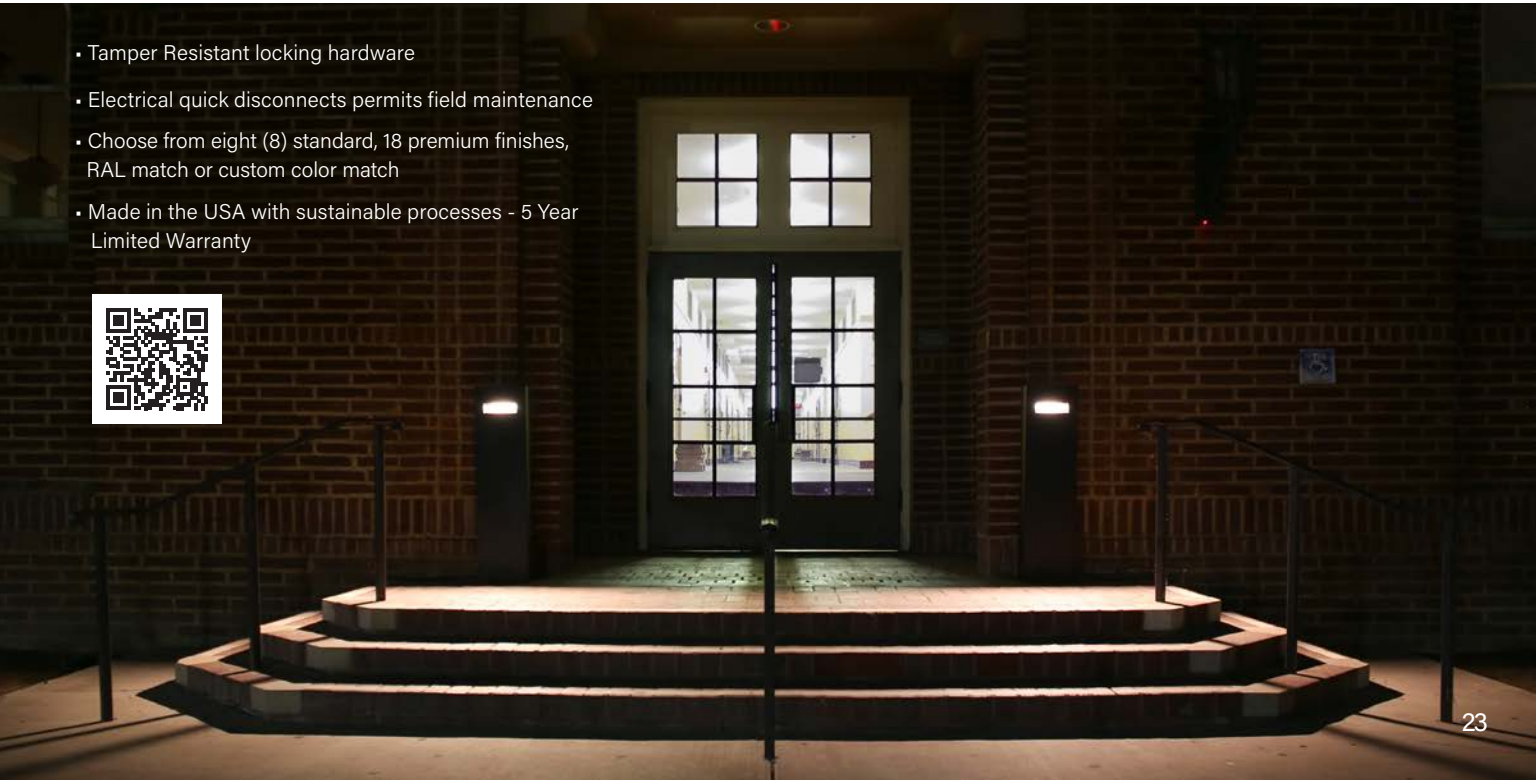



Indirect

YUKON[®] STEPLIGHT

Our Yukon[®] Steplight blends seamlessly into any step or wall while providing functional well distributed illumination.

- Direct (10W; up to 499 delivered lumens)
- Indirect (12W; up to 481 delivered lumens)
- Three dimming options; ELV, INC, or 0/10V
- Adjustable heat sink allows for distribution adjustment in the field
- CCT 2700K, 3000K, 3500K and 4000K , 80 or 90 CRI
- High performance illumination allows for larger fixture spacing
- Adjustable recessed housing accommodates surrounding surface elements for a clean application
- Made in the USA with sustainable processes - 5 Year Limited Warranty

INDIRECT BACKPLATE OPTIONS

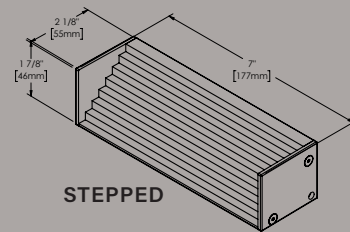

STEPPED

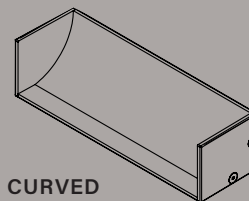

CURVED

ALL BACKPLATES & FACEPLATES

Choose from eight (8) standard, 18 premium finishes, RAL match or custom color match

INDIRECT FACEPLATE OPTIONS

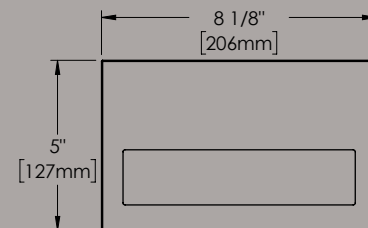

STANDARD



VISOR

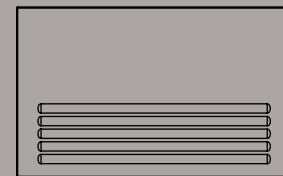

LOUVERED

DIRECT VERTICAL FACEPLATE OPTIONS

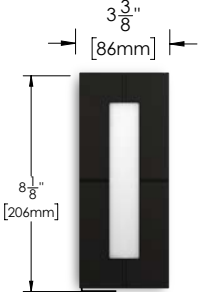



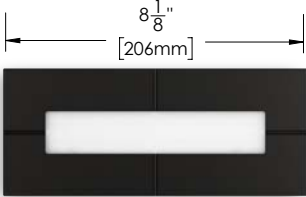

COMPASS LAYERED RIBBON DECO LOUVERED VISOR STANDARD

DIRECT HORIZONTAL FACEPLATE OPTIONS

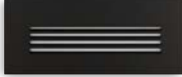

COMPASS

	
STANDARD	DECO
	
VISOR	LOUVERED
	
LAYERED	RIBBON



Direct

3" Dia

DEMI

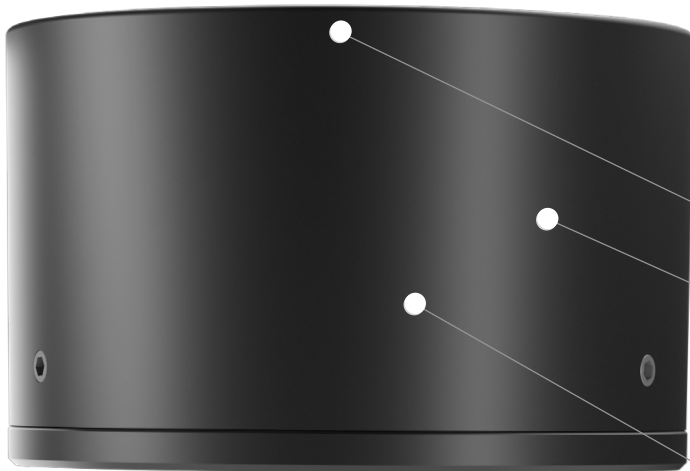

FIVE OPTIC OPTIONS

7°, 10°, 17.5°, 30°, 41°

9W; UP TO 518 DELIVERED LUMENS

80 CRI with 4 CCT options
ELV, INC, and 0-10V dimming
120-277 VAC

FIVE CAP STYLES

45°, 45° less weep hole, 90°,
90° less weep hole, flush



Floodlight

DEMI FLOODLIGHT

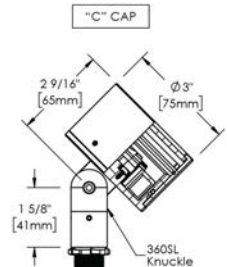
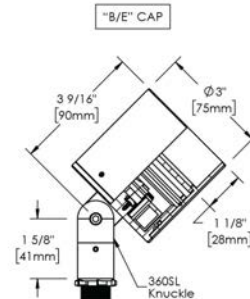
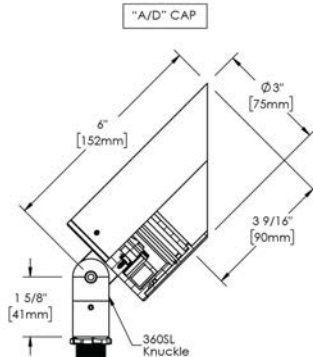
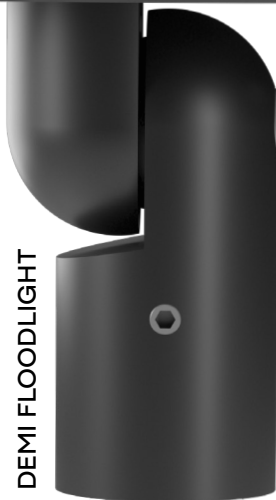

Introducing the DEMI family of fixtures. Available as a floodlight, catenary, and ceiling mount, the DEMI is one of our smallest line voltage fixtures yet. Don't let its size fool you. The Demi packs powerful performance in a small package.



DEMI CATENARY



DEMI CEILING MOUNT

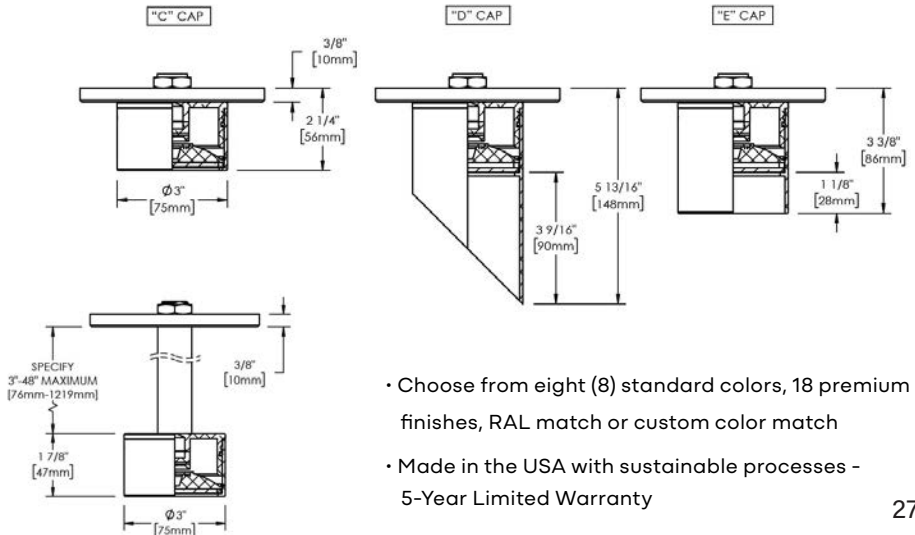
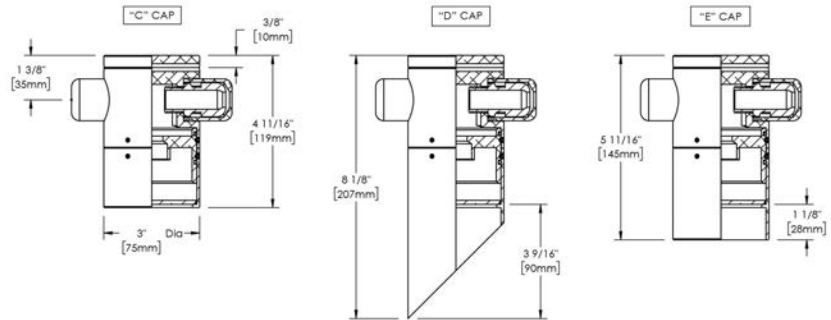

- Choose from eight (8) standard colors, 18 premium finishes, RAL match or custom color match
- Made in the USA with sustainable processes - 5-Year Limited Warranty

COMING SOON

• MINI YUKON

SURFACE MOUNT STEPLIGHT



AIMING •

LITESTICK



RIO

CEILING MOUNTS

CYPRESS

CRASH-RATED BOLLARD

LIT CAP OPTIONS

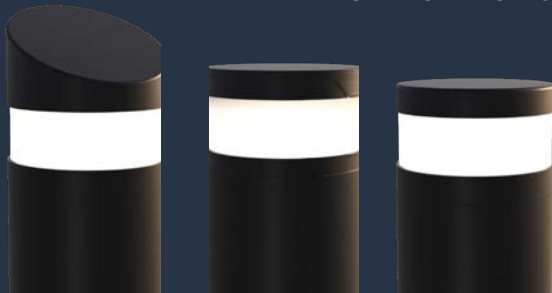

NON-LIT CAP OPTIONS

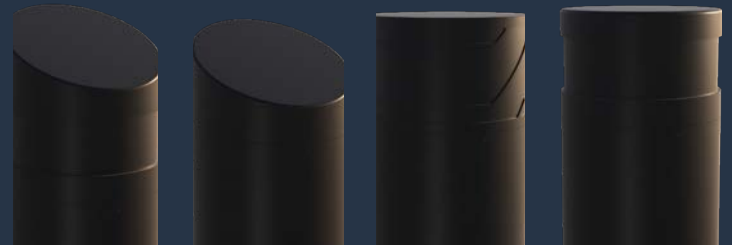



Facing a unique lighting challenge ?

Or perhaps you're just looking for a partner to help turn your vision into a reality?

B-K Customs CoLAB is your trusted custom lighting solutions partner. With over 4 decades of experience, 11,000+ custom designs and dedicated teams of experts, we are fearless and proven problem-solvers.

From simple modifications to advanced ground-up custom designs, the B-K team will even work with you to create solutions for lighting from other suppliers.



B-K provides that service we are looking for - flexible and willing to make adjustments based on (our) design needs, whether large or small.



Tao Ham
Lighting Designer



B-K wants my designs and applications to be as successful as I do.



Christa Belasco
Lighting Designer

- Fast lead times, exceptional results.
- Order what you need—no minimums.
- Simple or complex, we make it happen.
- A seamless, stress-free process.
- Designed your way, delivered with ease.



PHOTO CREDIT: RYAN FISCHER



PHOTO CREDIT: RYAN FISCHER

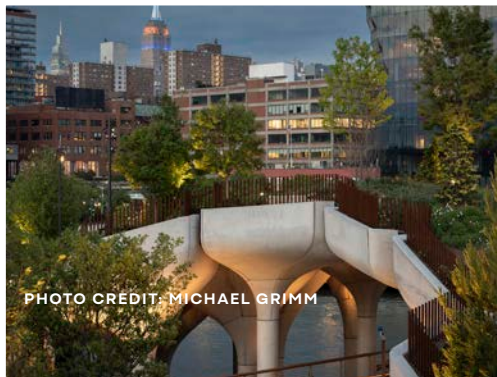

PHOTO CREDIT: MICHAEL GRIMM



PHOTO CREDIT: RYAN FISCHER

B-K LIGHTING®

shines globally delivering cutting-edge technology, enduring designs, innovative customization, and a commitment to our people, customers, and planet. With four decades of proven quality and award-winning American craftsmanship, we outperform and outlast the competition.

MADE IN THE USA

EMPLOYEE-OWNED



info@bklighting.com | 559.438.5800

www.bklighting.com

Proud corporate member of these organizations:

IALDLIRC

